

# **MapleMBSE 2024.1 Configuration Guide**

**Copyright © Maplesoft, a division of Waterloo Maple Inc.  
2024**

---

# MapleMBSE 2024.1 Configuration Guide

# Contents

Introduction .....	vii
1 Getting Started .....	1
1.1 Introduction .....	1
1.2 Overview of MapleMBSE Mapping .....	1
1.3 The MapleMBSE Configuration Plugin .....	2
Installing the Configuration Plugin .....	2
1.4 MSE Configuration Editor .....	4
1.5 Creating a Configuration File .....	9
1.6 Using the MapleMBSE Configuration File Editor to Create or Edit an MSE File .....	13
Introduction .....	13
Getting Started with the MapleMBSE Configuration File Editor .....	14
Selecting Templates .....	14
MBSE Wrapper tag .....	16
Datasource Widget .....	17
1.7 Launching MapleMBSE from the Command Line .....	17
1.8 An Introductory Example .....	18
2 Configuration Language Fundamentals .....	25
2.1 Notation .....	25
2.2 Overview of an MSE Configuration File .....	25
2.3 EcoreImport .....	26
3 Qualifiers .....	27
3.1 Attribute filter .....	27
3.2 Reference filter .....	28
3.3 Predicate filter .....	29
Defining the Predicate .....	29
Creating the Filter Logic for the predicate .....	29
Using the Predicate Filter .....	31
3.4 The Sorting Feature .....	31
Defining the Sorting Feature .....	32
Using the Sorting Feature .....	32
4 Query Path Expression .....	33
4.1 Query Path Expression Definition .....	33
5 Data Source .....	37
6 SyncTable Schema .....	39
6.1 SyncTable Schema Definition .....	39
6.2 Examples of SyncTable Schema .....	40
6.3 Mapping the Attribute Values of the Model Elements to the Columns .....	40
6.4 Mapping the Dimensions to the Records .....	41
6.5 Alternative and Group Dimensions .....	42
6.6 ReferenceDecomposition and ReferenceQuery .....	46

Mapping reference values with ReferenceDecomposition and ReferenceQuery .....	46
ReferenceDecomposition by Example .....	46
References by Dimensions or ReferenceQuery .....	48
6.7 Key Columns Defined in SyncTable Schema .....	49
6.8 The allow-empty Option .....	50
6.9 Using Default Value Generation in a Column .....	50
Limitations .....	51
Data Insertion Order with the Default Column .....	51
Using Default Value Generation to create Requirement IDs .....	53
7 SyncTable .....	55
8 Laying out SyncViews .....	57
8.1 Setting up a Workbook and Worksheets .....	57
8.2 Worksheet Template and View Layout .....	58
Table View Layout .....	58
Matrix View Layout .....	60
8.3 Making Worksheets Read-only .....	62
9 Capella Example .....	65
9.1 Sample MSE File for a Capella Model .....	65
Create the MSE File in the Eclipse Editor .....	65
Create the MSE File in a Text Editor .....	65
ecore Import .....	66
Data Source .....	66
synctable-schema .....	67
Worksheet Template .....	68
10 Rhapsody Example .....	73
10.1 Sample MSE File for a Rhapsody Model .....	73
Create the MSE File in the Eclipse Editor .....	73
Create the MSE File in a Text Editor .....	74
ecore Import .....	74
Data Source .....	74
synctable-schema .....	75
Worksheet Template .....	78
11 Teamwork Cloud Example .....	81
11.1 Sample MSE File for a Teamwork Cloud Model .....	81
Create the MSE File in the Eclipse Editor .....	82
Create the MSE File in a Text Editor .....	82
ecore Import .....	82
Data Source .....	82
List of Blocks from Data Source .....	83
synctable-schema .....	84
Worksheet Template .....	91
Index .....	95

# List of Figures

- Figure 1.1: Schematic Diagram of How MapleMBSE Works ..... 2
- Figure 5.1: Relationship between model elements ..... 37
- Figure 6.1: SimpleTree ..... 40
- Figure 6.2: SyncTable From Simple Tree ..... 41
- Figure 6.3: SyncTable From Simple Tree (add record keyword to top level  
Dimension ..... 42
- Figure 6.4: Simplified Model Number Two: Using Alternative and Group ..... 42
- Figure 6.5: Tree From Simplified Model Two ..... 43
- Figure 6.6: Table Made From The Tree of Simplified Model Two ..... 44
- Figure 6.7: Another Tree Made From Simplified Model Two ..... 45
- Figure 6.8: Another Table Made From Simplified Model Two ..... 45
- Figure 6.9: Target Model ..... 47
- Figure 6.10: Illustration of ReferenceDecomposition ..... 47



# Introduction

## MapleMBSE Configuration Guide Overview

MapleMBSE™ gives an intuitive, spreadsheet based user interface for entering detailed system design definitions, which include structures, behaviors, requirements, and parametric constraints.

The configuration file specifies the rules for how your data from your model is extracted and mapped into a table format along with how and where the extracted data is presented in an Excel spreadsheet.

In the following chapters, this guide will provide detailed instructions on working with configuration files and the configuration file language.

## Related Products

MapleMBSE 2024 requires the following products.

- Microsoft® Excel® 2010 Service Pack 2, Excel 2016 or Excel 2019
- Oracle® Java® SE Runtime Environment 8.

**Note:** MapleMBSE looks for a Java Runtime Environment in the following order:

- 1) If you use the -vm option specified in **OSGiBridge.init** (not specified by default)
- 2) If your environment has a system JRE ( meaning either: JREs specified by the environment variables JRE\_HOME and JAVA\_HOME in this order, or a JRE specified by the Windows Registry (created by JRE installer) ), MapleMBSE will use it.
- 3) The JRE installed in the MapleMBSE installation directory.

If you are using IBM® Rational® Rhapsody® with MapleMBSE, the following versions are supported: Rational Rhapsody Version 8.1.5, 8.3 and 8.4

- Teamwork Cloud™ server 2021.x, 2022.x and 2024.x
- Magic Collaboration Studio 2021.x, 2022x and 2024.x

If you are using Eclipse Capella™ with MapleMBSE, the following version is supported:

- 5.1,

If you are using Eclipse™, the following version is supported:

- 2023-3

Note that the architecture of the supported non-server products (that is, 32-bit or 64-bit) must match the architecture of your MapleMBSE architecture.

## Related Resources

Resource	Description
MapleMBSE Installation Guide	System requirements and installation instructions for MapleMBSE. The <b>MapleMBSE Installation Guide</b> is available in the <b>Install.html</b> file located in the folder where you installed MapleMBSE, or on the website. <a href="https://www.maplesoft.com/documentation_center/">https://www.maplesoft.com/documentation_center/</a>
MapleMBSE User Guide	Instructions for using MapleMBSE software. The <b>MapleMBSE User Guide</b> is available in the folder where you installed MapleMBSE.
MapleMBSE Applications	Applications in this directory provide a hands on demonstration of how to edit and construct models using MapleMBSE. They, along with an accompanying guide, are located in the Application subdirectory of your MapleMBSE installation.
Frequently Asked Questions	You can find MapleMBSE FAQs here: <a href="https://faq.maplesoft.com">https://faq.maplesoft.com</a>
Release Notes	The release notes contain information about new features, known issues and release history from previous versions. You can find the release notes in your MapleMBSE installation directory.

For additional resources, visit [http://www.maplesoft.com/site\\_resources](http://www.maplesoft.com/site_resources).

## Getting Help

To request customer support or technical support, visit <http://www.maplesoft.com/support>.

## Customer Feedback

Maplesoft welcomes your feedback. For comments related to the MapleMBSE product documentation, contact [doc@maplesoft.com](mailto:doc@maplesoft.com).

## Copyrights

- Microsoft, Windows, Windows Server, Excel, and Internet Explorer are registered trademarks of Microsoft Corporation.
- Teamwork Cloud, Cameo Systems Modeler, and MagicDraw are registered trademarks of No Magic, Inc.
- Eclipse is a trademark of Eclipse Foundation, Inc.
- UML is a registered trademark or trademark of Object Management Group, Inc. in the United States and/or other countries.



# 1 Getting Started

## 1.1 Introduction

The goal of this section is to introduce the elements of the configuration and template files and how they are connected together by defining a simple configuration file. The details about the elements are given in the following chapters.

A configuration file defines what data from a model is accessible and how it is presented in Excel. In order to do that, the configuration file must define the following elements.

- The content of the Excel workbook: how many and what types of worksheets it has.
- For each worksheet, define the area that is associated with the model data - the SyncView area and how it is displayed.
- For each SyncView area define what model data is displayed using a SyncTable.

## 1.2 Overview of MapleMBSE Mapping

The primary purpose of MapleMBSE is to map diagram-based models in UML into a table form that can be easily consumed and updated by an end user.

Mapping model information from diagram-based model form into table form requires a two step process.

First, a **SyncTable Schema** must be defined to convert the model to an intermediate table structure called a **SyncTable**.

A SyncTable Schema specifies how to find objects in a model starting with an object given by a **DataSource**. A pair of a DataSource and a SyncTable Schema defines one SyncTable.

Next, the **SyncView Layout** must be defined for how the SyncTable is displayed on a spreadsheet by specifying a layout and which columns of the SyncTable to include or omit. The resulting part of the spreadsheet displaying the SyncTable is called **SyncView**. The schematic flow of displaying a model in an Excel spreadsheet is shown in

*Figure 1.1 (page 2).*

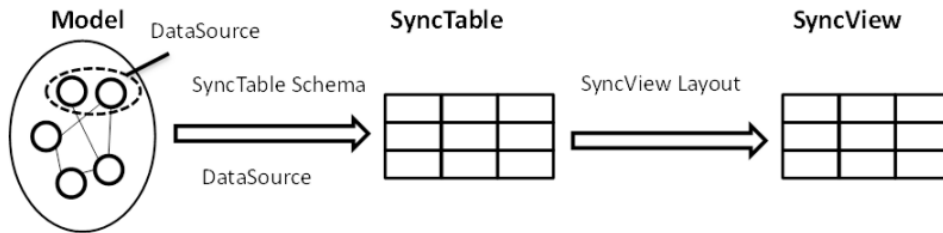

**Figure 1.1: Schematic Diagram of How MapleMBSE Works**

The definition of a DataSource, a SyncTable Schema, and a SyncView Layout is called an **MSE configuration**. The language used to define an MSE configuration is called MSE configuration language. In this guide we provide the specification of the MSE configuration language. For notation used in the specification, see *Notation (page 25)*. MSE configuration files are text files that can be edited and created with any text editor. However, it is recommended to use MSE Configuration Editor which provides convenient syntax highlighting and checking. For the installation instructions, see *MSE Configuration Editor (page 4)*. Examples in this guide use the MSE Configuration Editor.

## 1.3 The MapleMBSE Configuration Plugin

You can create an MSE file, with minimal manual coding, by installing the MapleMBSE plugin for CATIA NoMagic tools.

### Installing the Configuration Plugin

You can install the MapleMBSE Configuration plugin by doing one of the following:

- Install the plugin while you are installing MapleMBSE. For instructions, see the MapleMBSE Installation Guide, in your MapleMBSE installation directory.
- Use the CATIA NoMagic tools Resource/Plugin Manager

### Using the CATIA NoMagic tools Resource Manager to Install the MapleMBSE Plugin

1. In CATIA NoMagic tools, From the Help menu, select Resource/Plugin Manager.

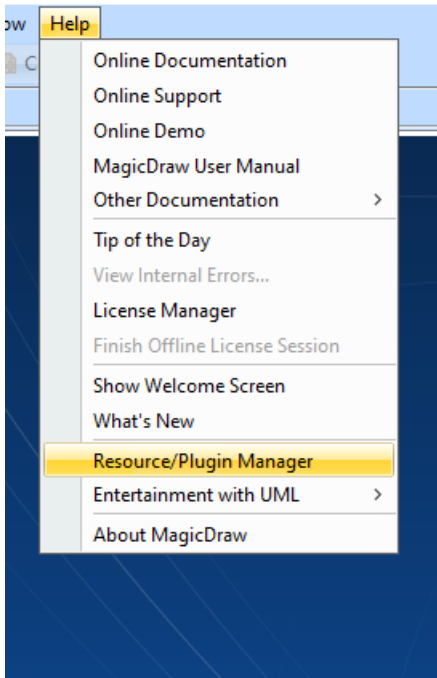

2. From the Resource/Plugin Manager window click Import.

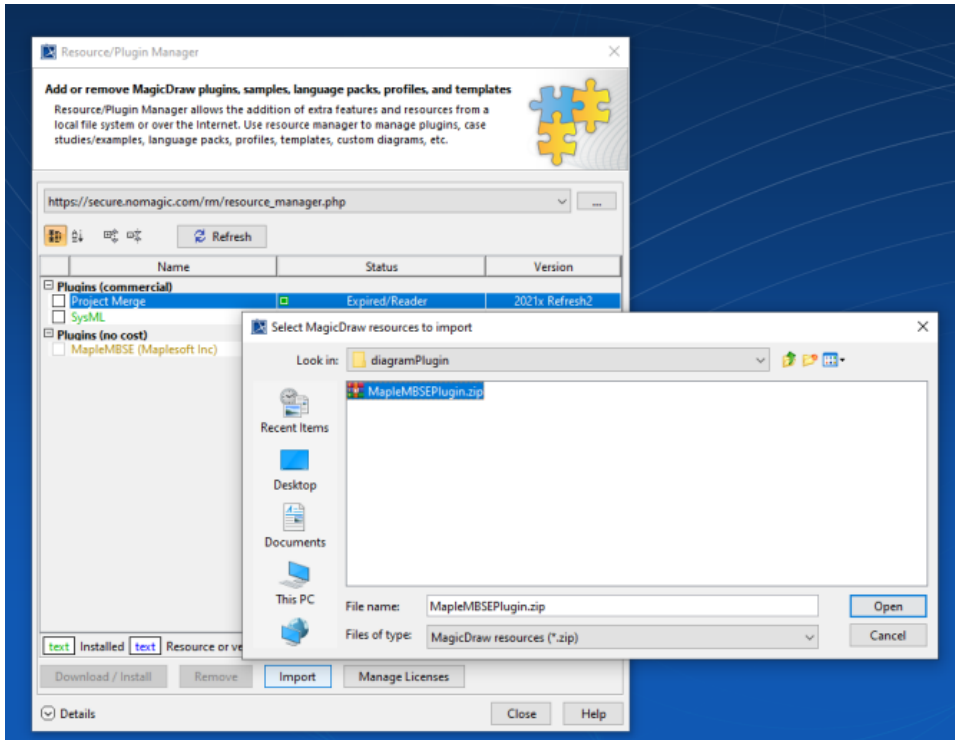

3. Go to your MapleMBSE 2024.1 installation directory, then go to the diagramPlugin subdirectory.
4. Select MapleMBSEPlugin.zip.
5. Click Open.
6. Click Import.

## 1.4 MSE Configuration Editor

The MapleMBSE Configuration Editor (a.k.a MSE Editor) is provided in the same package as MapleMBSE-Editor\_2024.1.zip and can be downloaded from:

<https://www.maplesoft.com/support/downloads/index.aspx#mbse>.

The MSE Editor is an Eclipse add-on, and you can install with the following steps:

1. Launch Eclipse (<https://www.eclipse.org/downloads/packages/installer>).
2. Select **Help**, then **Install New Software**.

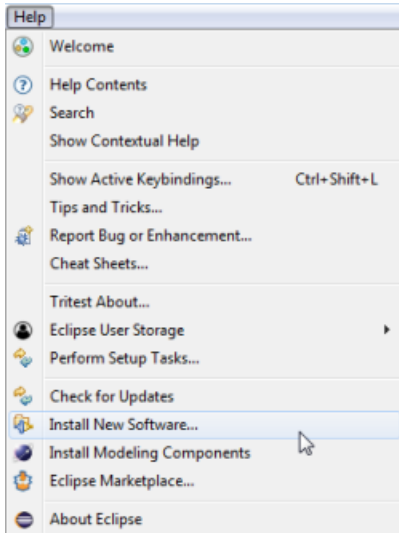

3. Click **Add** to display the Add Repository window.

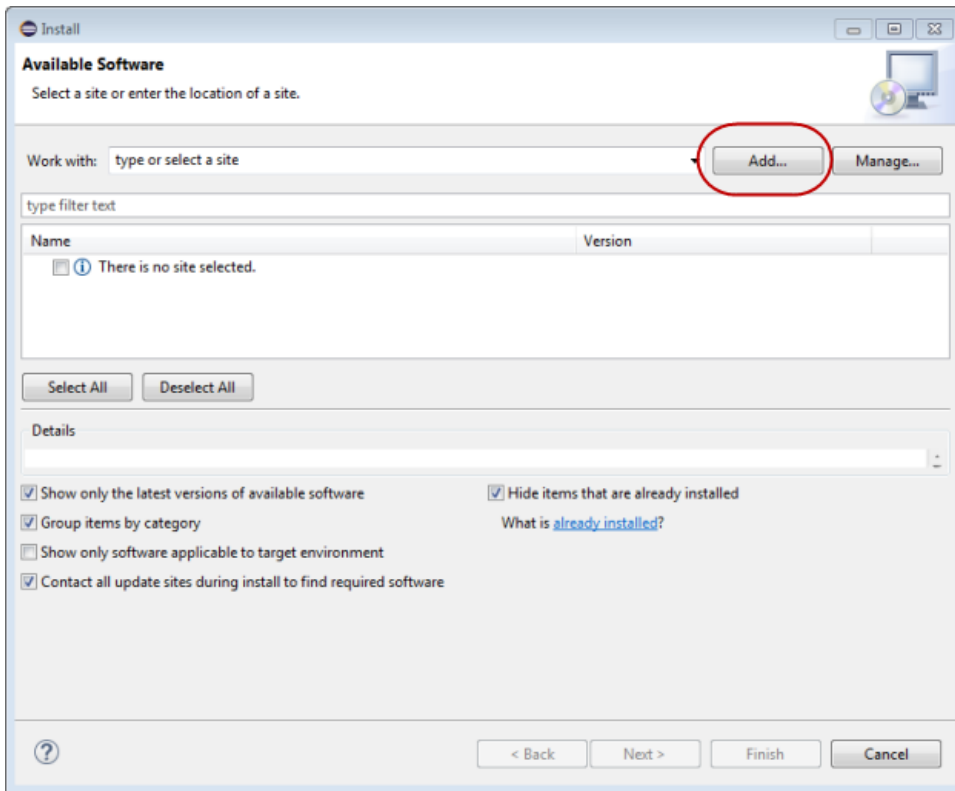

4. In the Add Repository window click **Archive**.

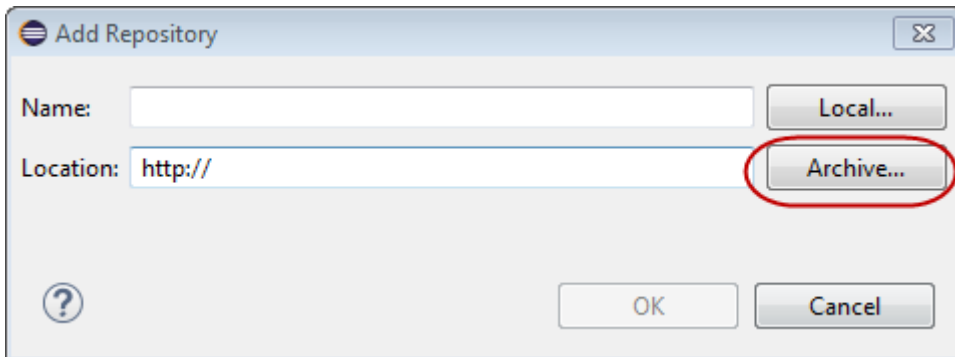

5. Find and select the MapleMBSE-Editor\_2024.1.zip file.

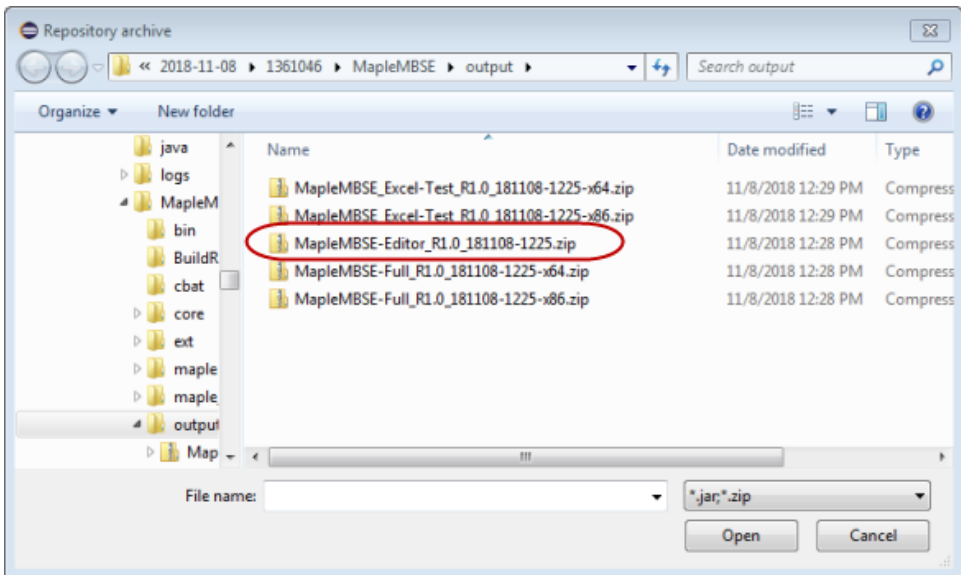

6. Click **Open**.

7. Click **OK**.

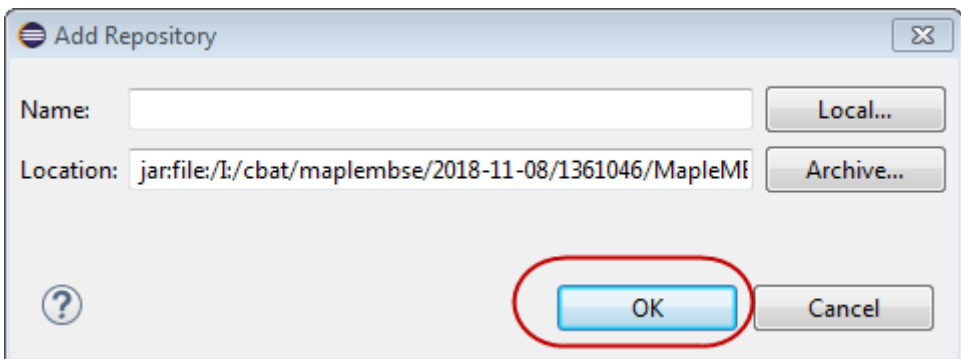

8. From the list of files, select MapleMBSE MSE Editor and then follow the instructions shown in the dialog.

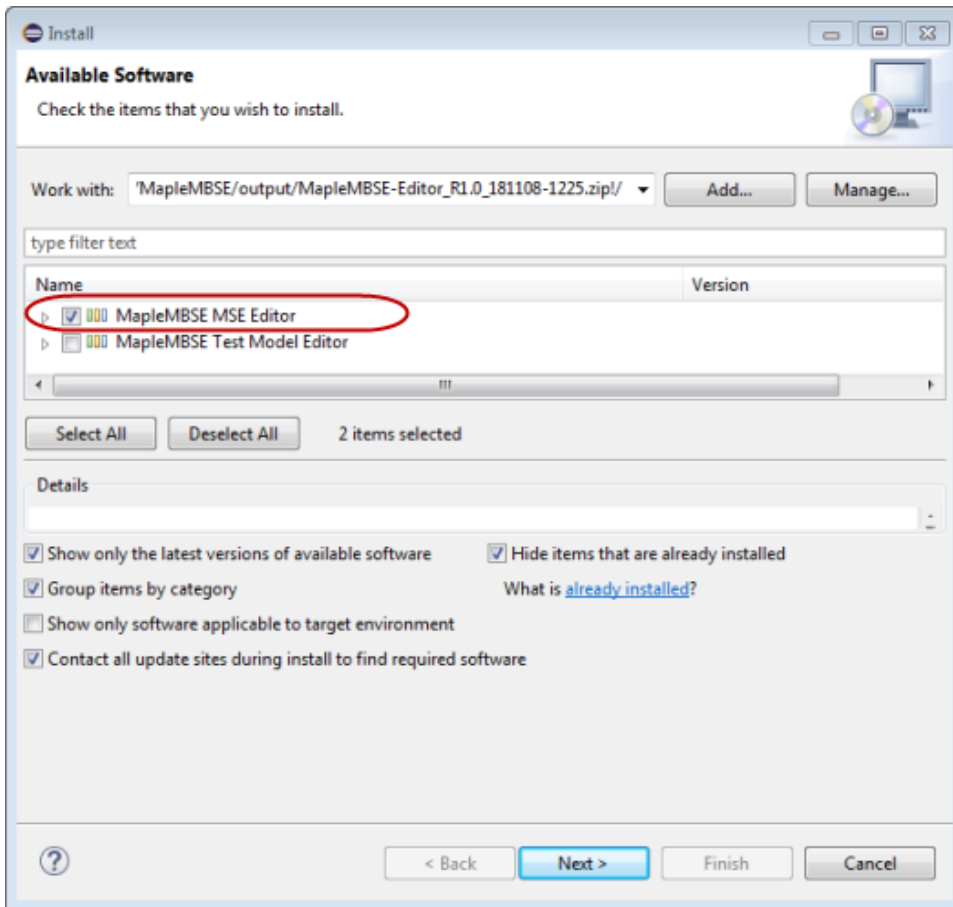

9. Click **Next**.



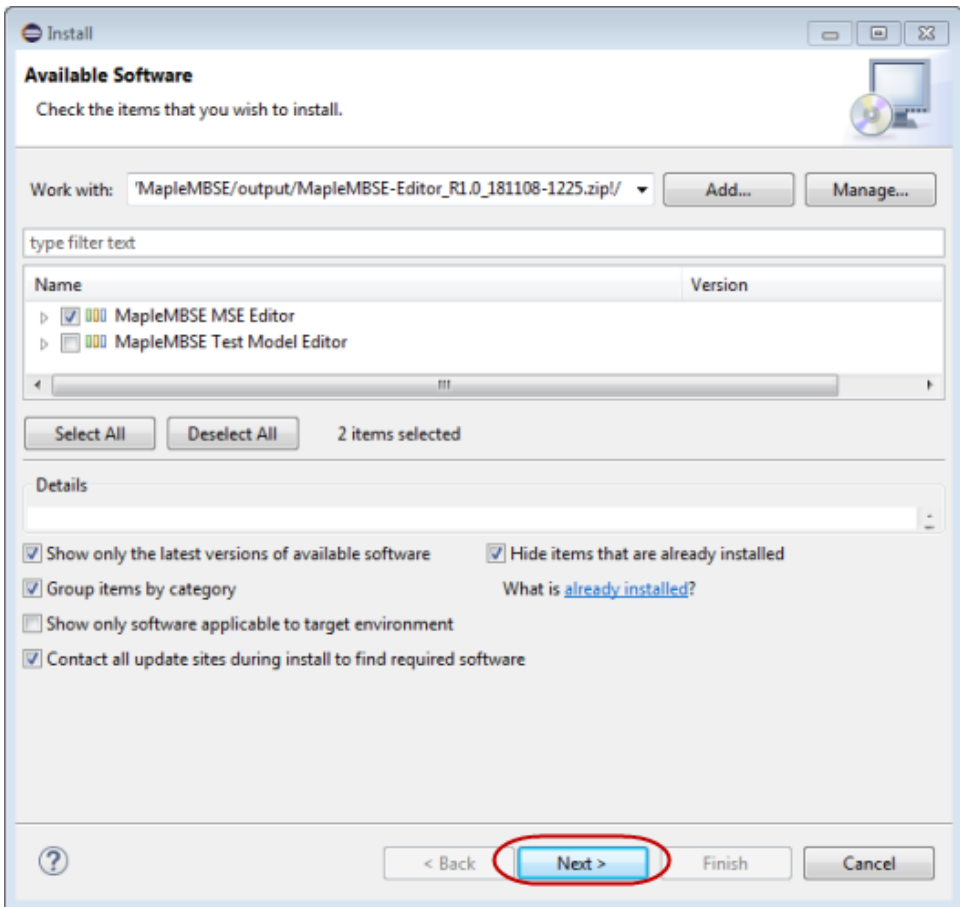

10. Click **Next**.
11. To proceed, accept the terms of the license agreements.
12. In the security warning dialog click **Install Anyway**.
13. Click **Finish**.
14. Restart Eclipse.

## 1.5 Creating a Configuration File

To use the editor, you first need to create a project folder for your configuration file(s) in your Eclipse workspace. Then, add an MSE file to your project file.

**Note:** Double-clicking an MSE file in the workspace launches the editor.

**To create the project folder and MSE file do the following:**

1. In Eclipse, select **File-> New-> Project-> General Project**.

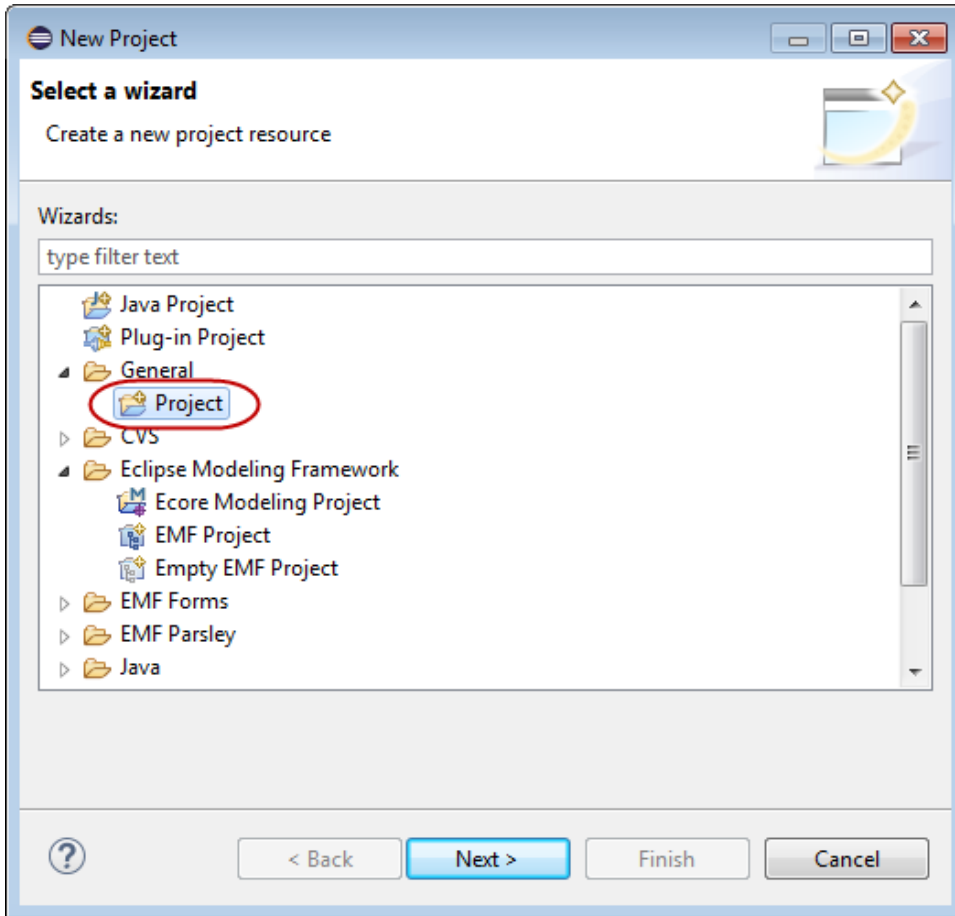

2. Click **Next**.
3. Enter a name for the project.

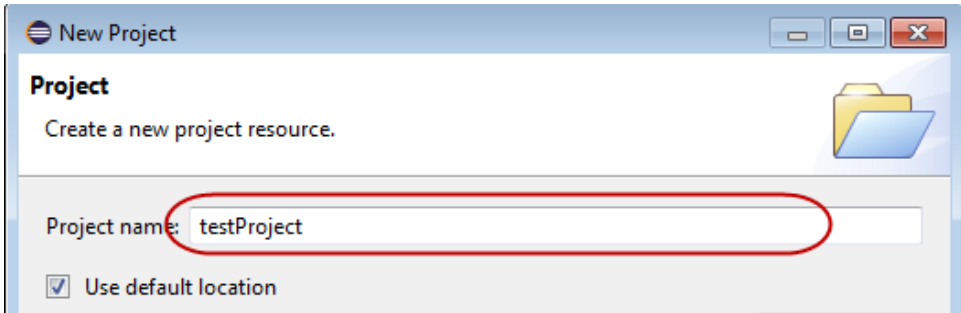

4. Check default location to save the project to your default Eclipse workspace. Otherwise, enter the path to the workspace you want to save the project to.
5. Click **Finish**.
6. Right-click on the newly created project, then select **New->File**.

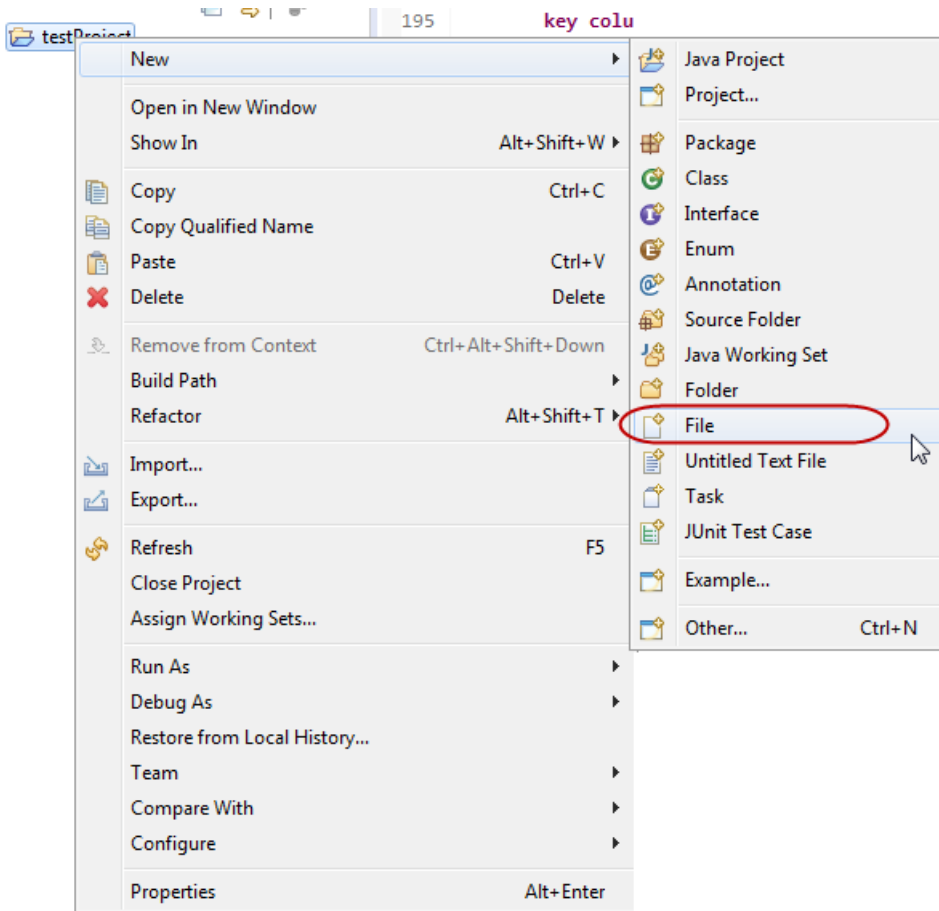

7. Enter a name for the new file.

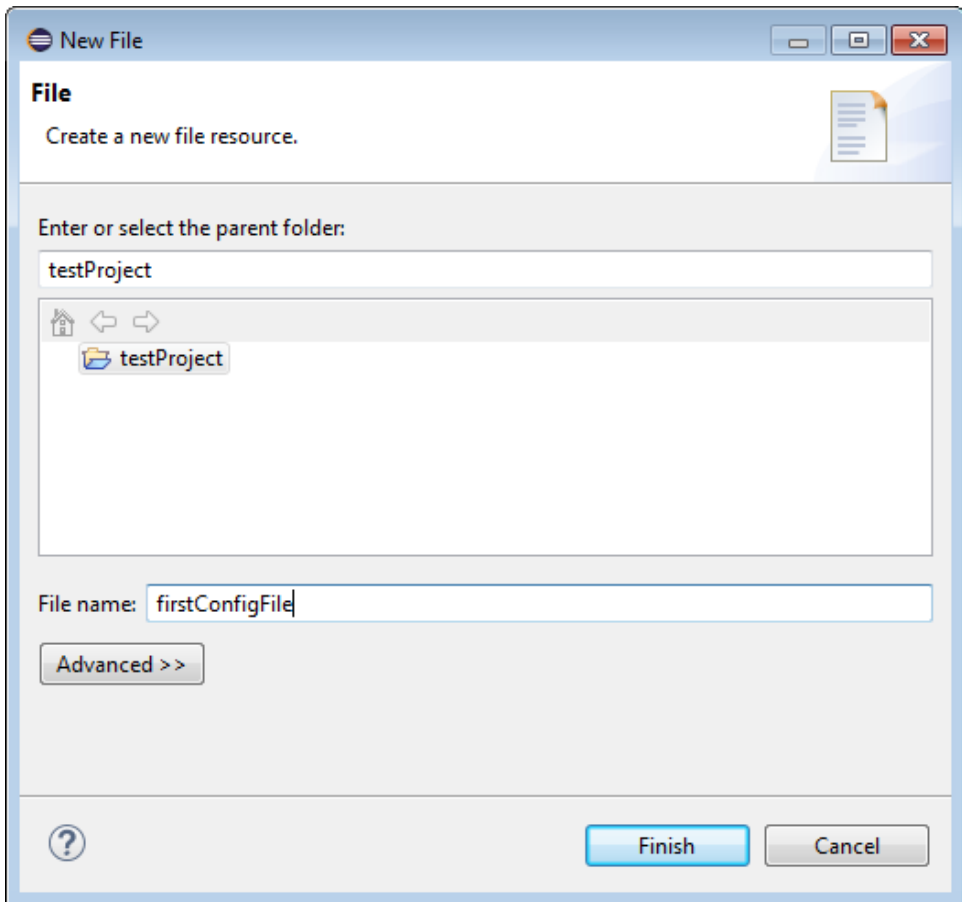

8. Click **Finish**.

## 1.6 Using the MapleMBSE Configuration File Editor to Create or Edit an MSE File

### Introduction

The MapleMBSE™ GUI editor is a plugin for CATIA No Magic products that provides a visual interface to create MapleMBSE configuration file (.MSE).

For experienced users responsible for maintaining the code for the configuration files, the GUI editor to make it easier to maintain the GUI editor code and to add more templates in the future.

The MapleMBSE Configuration editor is typically installed with MapleMBSE. If in your situation, the MapleMBSE Configuration has not been installed along with MapleMBSE, you can find instructions in the **MapleMBSE Installation and Licensing Guide**.

## Getting Started with the MapleMBSE Configuration File Editor

Once the MapleMBSE Configuration File editor has been installed, you are ready to get started.

1. Launch your CATIA No Magic product (example, MagicDraw).
2. From the menu bar, select MapleMBSE then, ConfigurationEditor.
3. The Configuration Editor tab opens.

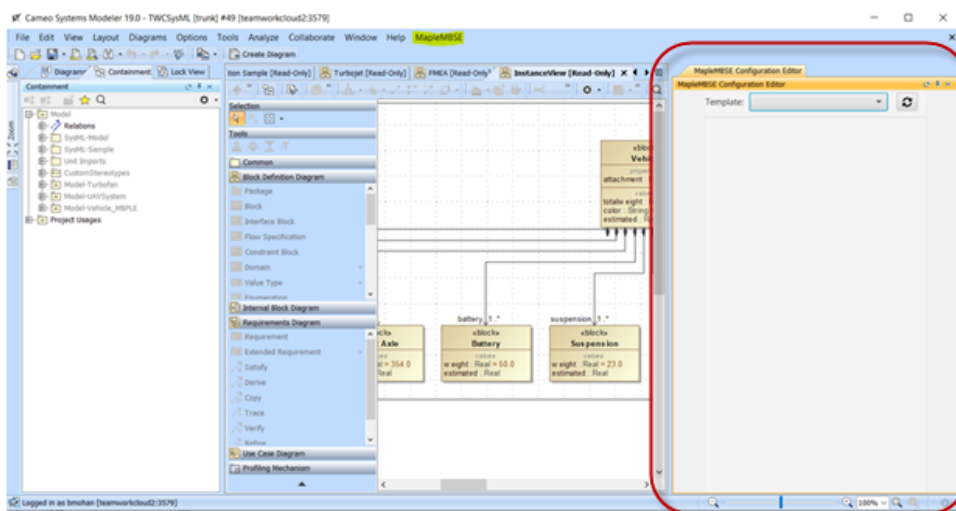

## Selecting Templates

From the MapleMBSE Configuration Editor tab:

1. Select the template you want to use from the Template list. The template is now loaded into the MapleMBSE Configuration Editor panel.

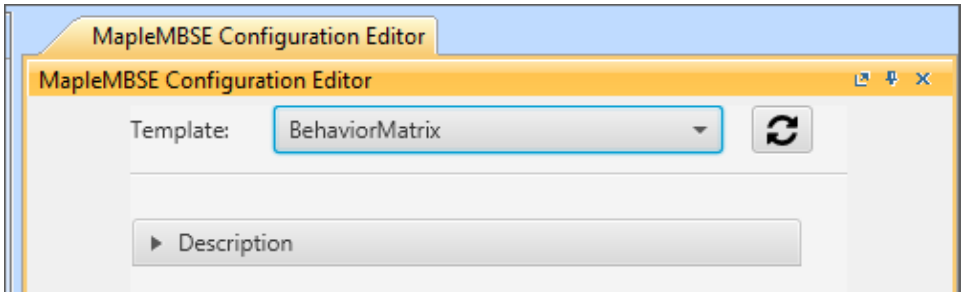

2. For a complete description of the template you have selected, click the arrow beside Description, or see the subsection below.
3. Drag the appropriate input from your project into the input field for the MapleMBSE Configuration Editor template (under the Description section).
4. Select other options such as Activity Nodes as desired

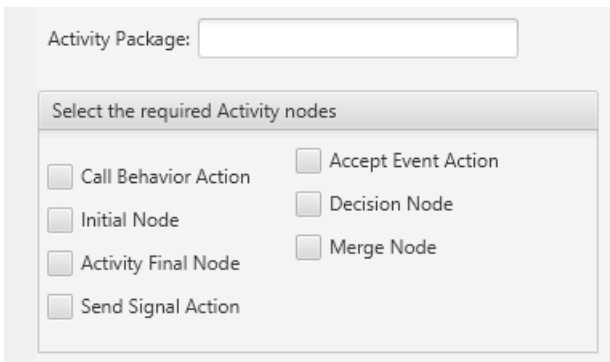

Notes:

The Dimensions window provides an updated preview of the configuration file before it's created.



The Sample window provides an updated preview of the model worksheet.

Sample				
ActivityTable	FunctionalFlowMatrix		ControlFlowMatrix	
Activities	Call Behavior Action	Behavior	Initial Node	Final Node
Display Notification				
Display Notification	trigger vibration			
Display Notification	receive phone notification			
Display Notification	receive message notification	Message Notification		
Display Notification	receive alarm notification			
Display Notification	receive notification	Receive Notification		
Display Notification			start	

5. Click **Export** to create the configuration file.

**Note:** By default, the Export button is disabled until the user provides enough data to the template. For example dragging and dropping the correct model elements to the data sources.

## MBSE Wrapper tag

MbseWrapper is tag that wraps a native widget to extend the functionality of the wrapped widget.

The syntax for using the MbseWrapper tag is:

```
<MbseWrapper>
<Widget/>
</MbseWrapper>
```

Where Widget is one of the following native Widgets:

- CheckBoxMbse
- ComboBoxMbse
- DataSourceMbse
- DatePickerMbse
- EClassQpeValidator
- ListViewMbse
- RadioButtonMbse
- SliderMbse
- SpinnerMbse
- StereotypeQpeValidator



- TextFieldMbse
- ToggleButtonMbse

## Datasource Widget

### DataSourceMbse

The user drags and drops elements, from the containment tree for example, and the text field displays information about it. The image below shows a title and a text field where the users would drop their context package. Next, while clicking on the Export button and depending on its configuration, the query for the dropped elements will be included.

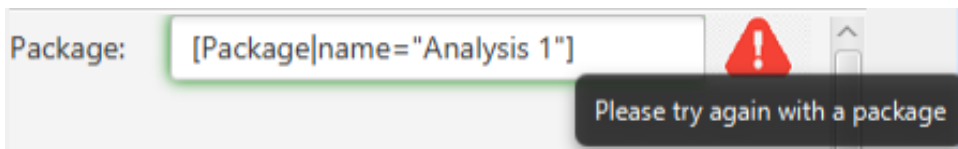

## 1.7 Launching MapleMBSE from the Command Line

MapleMBSE can be launched from the command line by executing the MapleMBSE.exe command in the installation directory. The command has the following syntax.

```
MapleMBSE.exe [/R <memsize>] [/L <logfile>] [/E <excel.exe>] [[/I | CONFIG(*.MSE)]
[MODEL]]
```

- If you specify **CONFIG** (must be \*.MSE) and **MODEL** files, it launches MapleMBSE with these files. If you do not specify a **MODEL** or **CONFIG** file, you will be asked for these files in a subsequent dialog.
- If you specify **/I**, MapleMBSE.exe will always ask for the MSE file in a dialog and regard the first non-slash argument as a model file.
- **MODEL** can be a local file or URI. For example, consider a model file on the Teamwork Cloud server:  
 = "twc://[SERVER:PORT]/[PROJECT][?[username=USERNAME][&password=PASSWORD][&branch=BRANCHNAME][&version=VERSION]"

**Note:** If you omit some items, MapleMBSE will ask for them in the dialog

- If you do not specify any file arguments, it checks if MapleMBSE.xlsm exists in the AddIns directory inside the directory with MapleMBSE.exe. If found, MapleMBSE launches it.
- **/R <memsize>**: (optional, default=905) Memory address space in MB to be reserved for Java VM in the Excel process.
- **/L <logfile>**: (optional, default="MapleMBSE\_Launcher.log") Log file name, relative to %USERPROFILE% or in absolute path.
- **/E <excel.exe>**: (optional) Path of EXCEL.EXE  
If it's not specified, the registry entries will be used:
  - = HKEY\_CLASSES\_ROOT\CLSID\<CLSID of "Excel.Application">\LocalServer32
  - = HKEY\_CLASSES\_ROOT\CLSID\<CLSID of "Excel.Application">\LocalServer
  - = HKEY\_CLASSES\_ROOT\Wow6432Node\CLSID\<CLSID of "Excel.Application">\LocalServer32
  - = HKEY\_CLASSES\_ROOT\Wow6432Node\CLSID\<CLSID of "Excel.Application">\LocalServer

Notes:

- After you have launched MapleMBSE successfully from the command line, if you want to restart MapleMBSE, use the shortcut key combination CTRL+Shift+G.
- You can launch MapleMBSE from the command line using `&cache=true`. For example:

```
MapleMBSE.exe "C:\Program Files\MapleMBSE 2024\Example\TWC\19.0\TWC-Sample.MSE" "twc://teamworkcloud:3579/Model?username=****&password=****&cache=true"
```

## 1.8 An Introductory Example

In this example, we want to define a configuration that allows us to view and update top-level packages in a UML model. The first step is to import the definition of a UML metamodel. A metamodel, called an Ecore, defines the types of elements a UML model may have and their relationships. The definitions inside the configuration file that allow us to access different elements of a model rely on the structures defined by the imported metamodels. To import an Ecore metamodel, use an **EcoreImport** construct as follows.

```
import-ecore "http://www.eclipse.org/uml2/5.0.0/UML"
```

There are two steps in converting model data into its representation in Excel. First, we define a **SyncTable Schema** that converts the data into an intermediate table called a **SyncTable**. In the second step, the **SyncView Layout** defines how a SyncTable is displayed on a spreadsheet by specifying which SyncTable columns will be displayed, as well as their position and layout. The resulting part of the spreadsheet displaying the SyncTable is called the **SyncView**.

A SyncTable Schema defines how a set of model elements is mapped to a table structure. In this example, we define a SyncTable Schema called PackagesTable.

```
synctable-schema PackagesTable{
|
}
```

Note the MSE Editor performs some testing of the correctness of the defined structures. The syntax error highlighting the closing bracket indicates that definition is incomplete without defining a dimension.

We define the top level dimension to be an element of a Package type.

A dimension is a basic structure of a SyncTable schema. Each dimension corresponds to a model element. The first dimension of a SyncTable Schema is a Top Level Dimension. It represents the type of element to which the schema applies. Each following dimension is defined with respect to the preceding one.

```
synctable-schema PackagesTable{
  dim [[Package]]
}
```

A dimension consists of columns. Each column represents an attribute of the element that the dimension describes. To identify the element some of the columns must be designated as key columns. They must represent the attributes of the element that would allow you to identify it uniquely. Without the definition of the key column(s) the definition of the dimension is incomplete. It is indicated by a syntax error.

For a package, its name can identify it uniquely. We define a key column that corresponds to the 'name' attribute of a Package class.

```
synctable-schema PackagesTable {
  record dim [Package] {
    key column /name as PackageName
  }
}
```

This SyncTable schema definition allows you to view, add and delete packages by referring to their name. To create a SyncTable, the schema must be applied to a **Data Source**. A Data Source defines a set of model elements. The Data Source representing the top-level data structure of a model has the name **Root**. This is a reserved name. The Root is declared as follows.

```
data-source Root[Model]
```

The declaration specifies that the type of the top-level data structure is Model. You can see the types and the structure of a UML model by opening the .uml file in a text editor. For example, the following is a snippet from UserGuide.uml in the installer, found in the

<MapleMBSE>\Examples\UserGuide directory, where <MapleMBSE> is your MapleMBSE installation directory.

```
<?xml version="1.0" encoding="UTF-8"?>
<uml:Model xmi:version="20131001"
xmlns:xmi="http://www.omg.org/spec/XMI/20131001"
xmlns:uml="http://www.eclipse.org/uml2/5.0.0/UML"
xmi:id="_D2UUEM_MEee6666BhKb4Cg" name="UserGuide">
  <packagedElement xmi:type="uml:Package" xmi:id="_Oeqy0M_MEee6666BhKb4Cg"
name="Package1" visibility="public">
    ...
  </packagedElement>
  <packagedElement xmi:type="uml:Association" ...>
    ...
  </packagedElement>
  ...
</uml:Model>
```

The text representation of the model is written in XML. The model and its content are represented by XML elements. The top-level element is defined by the start and end tags:

```
<uml:Model ...>
...
</uml:Model>
```

The element is a "uml:Model" that is of a type Model defined by the "uml" namespace. The "uml" namespace is defined among the attributes of the Model element.

```
xmlns:uml="http://www.eclipse.org/uml2/5.0.0/UML"
```

The definition matches the EcoreImport we are using in the configuration file. So the type "Model" used in the definition of the Root Data Source is the same as "uml:Model" in the model file. We want to apply the PackageTable schema to define packages inside a model, and the type of the data source it applies to is Package. We define a data source that represents packages in a model as follows.

```
data-source topPackages=Root/packagedElement[Package]
```

This statement defines a new data source called `topPackages`. The syntax `Root/packagedElement` means we are looking at the Model elements inside the **Root** that are defined by the tag `packagedElement`. The syntax `packagedElement[Package]` means we are choosing only those `packagedElement`s that have type `Package`. Looking back at the UML file, we can see that `packagedElement` could have at least two types: `Package` or `Association`. We are choosing only the ones of type `Package`.

To create a `SyncTable` we apply the `SyncTable` schema to the Data Source using angle brackets.

```
syncTable packagesTable = PackagesTable<topPackages>
```

The next step is to define how the SyncTable is represented in an Excel worksheet. We do this by defining a **Worksheet Template**. We define a Worksheet Template called `Packages`.

```
worksheet-template Packages|
```

The template uses one argument `p` of type `PackagesTable`. That is, `p` must be a SyncTable created from the SyncTable schema `PackagesTable`.

```
worksheet-template Packages(p : PackagesTable){
  |
}
```

The Worksheet Template must define where the SyncView for the given argument is placed and what orientation it has. In this example we choose the SyncView for the argument `p` to be a vertical table (named `tab1`) and start in cell B3 (row 3, column 2). The section defining `tab1` is called **SyncView Layout**.

```
worksheet-template Packages(p : PackagesTable){
  vertical table tab1 at (3,2) = p {
    |
  }
}
```

We also need to specify which columns of the SyncTable should be included in the SyncView. A SyncTable column becomes a field in a SyncView record. A record is simply the collection of fields. In a vertical SyncView a record is a row in the table and the fields are the cells in the row (see the **Operations Overview** section in **Chapter 2** of the **MapleMBSE User Guide** for more details). Some fields in a record must be marked as key fields to indicate that those fields are used to identify the record uniquely. In the `PackagesTable` schema there is only one column, **PackageName**. It is a key column and should be used as a key field. `PackageName` is of the `String` data type. The definition of the SyncView layout is then as follows.

```
worksheet-template Packages(p : PackagesTable){
  vertical table tab1 at (3,2) = p {
    key field PackageName : String|
  }
}
```

We also want to indicate that the column should be sorted in ascending order when a model data is loaded or when sort operation is performed after adding new data. We do so by specifying the name of the field in the sort keys.

```
worksheet-template Packages(p : PackagesTable) {  
    vertical table tab1 at (3,2) = p {  
        key field PackageName : String  
        sort-keys PackageName  
    }  
}
```

Finally, we need to define a workbook that consists of a worksheet based on the defined template applied to an instance of a SyncTable.

```
workbook {  
    worksheet Packages(packagesTable)  
}
```

The final content of the configuration file is as follows.

```
import-ecore "http://www.eclipse.org/uml2/5.0.0/UML"  
  
data-source Root[Model]  
data-source topPackages=Root/packagedElement[Package]  
  
synctable-schema PackagesTable {  
    record dim [Package] {  
        key column /name as PackageName  
    }  
}  
  
synctable packagesTable = PackagesTable<topPackages>  
worksheet-template Packages(p : PackagesTable) {  
    vertical table tab1 at (3,2) = p {  
        key field PackageName : String  
        sort-keys PackageName  
    }  
}  
  
workbook {  
    worksheet Packages(packagesTable)  
}
```

The resulting file can be found in **GettingStarted.MSE**, in the MapleMBSE Configuration Editor Package.

You can use the configuration file with any UML model. For example, opening MapleMBSE with this configuration file and **<MapleMBSE>\Example\UserGuide\UserGuide.uml**, where **<MapleMBSE>** is the location where MapleMBSE is installed, gives the following result.

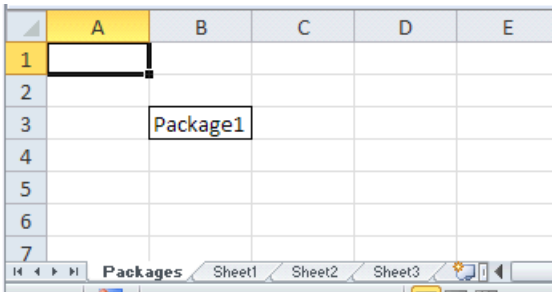

The SyncView area of the worksheet can be highlighted by choosing the name of the corresponding SyncView in the name box. The SyncView name has the following format.

`_MapleMBSE_SyncView_<Worksheet Name>_<SyncView Layout Name>`

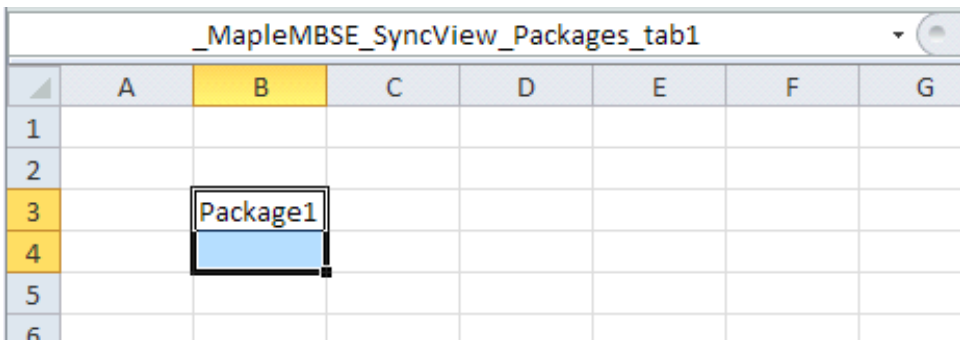

You can add new packages to the model by adding rows in the SyncView area or by entering them in the insertion area (cell B4). See the *MapleMBSE User Guide, Chapter 2, Adding Model Elements* for more details.

For convenience, it is good to add a heading to the column explaining what it is and maybe change the width of the column. Any such formatting changes done when editing a model are not saved with the model data. Instead, they should be done in a separate file called **Template File**. A template file is an Excel file that has the same base name as the configuration file and is placed in the same folder. MapleMBSE looks for the sheets in the workbook that match the names of the worksheets defined by the configuration file and loads the specified SyncViews into that sheet. To define a template file for our example, we need to create an Excel file with the name that matches the name of the configuration file and contains a sheet called Packages.

To create the template for this example, we define a new Excel workbook. We name one of the sheets Packages, and delete others. The data with the package name is displayed in column B starting with row 3. We can define the heading for the column in cell B2 and increase the width of the column.

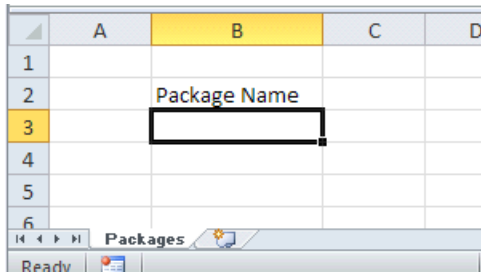

The screenshot shows an Excel spreadsheet with columns A, B, C, and D, and rows 1 through 6. Column B is highlighted in yellow. Cell B2 contains the text "Package Name". Cell B3 is selected and contains an empty text box with a black border. The status bar at the bottom indicates "Ready" and "Packages".

	A	B	C	D
1				
2		Package Name		
3				
4				
5				
6				

We save the template file with the same base name as the configuration file and in the same folder. Now if we open MapleMBSE with the configuration file and the example model UserGuide.uml we get the following.

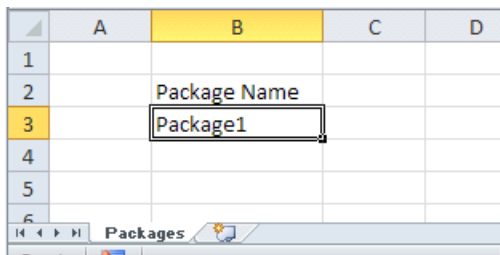

The screenshot shows the same Excel spreadsheet as above, but now cell B3 contains the text "Package1". The status bar at the bottom indicates "Ready" and "Packages".

	A	B	C	D
1				
2		Package Name		
3		Package1		
4				
5				
6				

**Tip:** the template file for this example can be found in **GettingStarted.xls**, in the same place with **GettingStarted.MSE**.

Another way to create a template could be to open a model with the configuration file as we did before, then save it as an Excel file using **Add-Ins > MapleMBSE > Export To Excel File**. This way we have the right number of sheets with their names. It is also easier to judge where the headings need to be added and how wide the columns should be. Any model data loaded in the tables should be removed. If it is left in the template it may create confusion when MapleMBSE uses the template. MapleMBSE will load SyncViews according to the specifications in the configuration file, so some data may be overwritten and some may not, depending on the model file with which the template is opened.



## 2 Configuration Language Fundamentals

### 2.1 Notation

The formal grammar of MSE Configuration Language is given using a simple Extended Backus-Naur Form (EBNF) notation. Each rule in the grammar defines one symbol, in the form:

```
symbol ::= expression
```

The following notations are used in expressions.

Notation	Usage
'string'	literal string matching the string between the quotes
(expression)	expression is treated as a unit
A*	0 or more occurrences of A
A+	1 or more occurrences of A
A?	0 or 1 occurrence of A
A   B	A or B
<A>	name of an element of type A

For reference see <https://www.w3.org/TR/2008/REC-xml-20081126/#sec-notation>

### 2.2 Overview of an MSE Configuration File

The following is the formal definition of the configuration file.

```
MSEConfiguration ::= EcoreImport*
```

```
WorkbookInstance &  
( DataSource  
| SyncTableSchema  
| SyncTable  
| WorksheetTemplate  
)*
```

In MSEConfiguration, EcoreImports come first, and then other elements can be specified in any order. The definitions of the elements are given in the following chapters. The following is an example of the procedure for writing an MSE Configuration file.

1. Define a Data Source and a SyncTable Schema.
2. Define a SyncTable with the pair of Data Source and SyncTable Schema.
3. Define the view and the layout of the SyncTable on WorksheetTemplate.

4. Define a worksheet in the WorkbookInstance with the pair of the WorksheetTemplate and SyncTable.

## 2.3 EcoreImport

EcoreImport declares the type of model to be edited with the configuration file. A type of model is defined by specifying an IRI of a metamodel definition. A metamodel, called an Ecore, defines types of elements a model may have and their relationship. Model elements and their attributes are queried using the structural elements defined by EcoreImports. The formal syntax of EcoreImport declaration is as follows.

```
EcoreImport ::= 'import-ecore' '""IRI""' ('as' ID)
```

In the *'import-ecore' ""IRI"" ('as' ID)* (page 26), IRI is an identifier of the Ecore metamodel in the form of IRI (International Resource Identifier). Different types of models have their own metamodels. The following is a list of the available Ecore models.

Type	IRI
UML	<a href="http://www.eclipse.org/uml2/4.0.0/UML">http://www.eclipse.org/uml2/4.0.0/UML</a>
SysML	<a href="http://www.eclipse.org/papyrus/sysml/1.4/SysML">http://www.eclipse.org/papyrus/sysml/1.4/SysML</a>
Teamwork Cloud 19.0	<a href="http://www.nomagic.com/magicdraw/UML/2.5.1">http://www.nomagic.com/magicdraw/UML/2.5.1</a>
Teamwork Cloud 2021.x	<a href="http://www.nomagic.com/magicdraw/UML/2.5.1.1">http://www.nomagic.com/magicdraw/UML/2.5.1.1</a>
Teamwork Cloud 2022.x	<a href="http://www.nomagic.com/magicdraw/UML/2.5.1.1">http://www.nomagic.com/magicdraw/UML/2.5.1.1</a>
Rhapsody	<a href="http://w3.ibm.com/Rhapsody/api/">http://w3.ibm.com/Rhapsody/api/</a>
MapleMBSE metamodel	<a href="http://maplembse.maplesoft.com/common/1.0">http://maplembse.maplesoft.com/common/1.0</a>

## 3 Qualifiers

Qualifiers are used as a way to specify the type of model elements that you want to query or create.

The basic qualifier syntax is as follows:

[Classifier|filter="value"] where a *Classifier* is a type of element, such as a *Class*.

The *filter* must be an *EAttribute*, which is a property that belongs to the *Classifier* element. There is an option to use *EReference* as filter but the syntax differs.

The formal definition of a Qualifier is given in the table below.

Qualifier	::=	'[' (EcoreImport '::') ? EClassifier ( ' ' ) ((index=INT)? ( ' ' (FeatureFilter (',' FeatureFilter)*)? ( ' ' (Sorting (',' Sorting)*)?)? )? )   ((FeatureFilter (',' FeatureFilter)*) )? ' ]'
FeatureFilter	::=	AttributeFilter   ReferenceFilter  PredicateFilter
AttributeFilter	::=	(EcoreImport '::')? EAttribute '=' STRING
ReferenceFilter	::=	(EcoreImport '::')? EReference '=' ? Qualifier
Sorting	::=	(EcoreImport '::')? EStructuralFeature

### 3.1 Attribute filter

Filters, either attribute or reference based, are applied in two scenarios, when gathering elements from the model and when creating new elements from scratch.

The first scenario, when querying the model, attribute filters simply verify that the real value and the value used in the configuration files are the same. Then, only those that match are added to the syncview.

Conversely, the attribute filter when creating a new element, has a different meaning. In this scenario, this kind of filter is initializing some attributes of the newly created element. For example, the following qualifier [Property|aggregation="composite"] has two functions. The first one, displaying only those properties with AggregationKind

equals to composite, and second, initializing the aggregation attribute with the value composite.

## 3.2 Reference filter

Reference filter has also the querying-creating duality, despite the different natures of attributes and references. The differences between attributes and references are analogous to the differences of basic types and objects like in other programming languages. References are used to point to hard-typed Classifiers, which have their owned attributes and references. Providing an expected value for an attribute is easy; strings, integer, boolean, and other basic types have the same values each time the model is queried. But it is impossible to provide a constant value for a reference and use it to filter, pointers change each time, the memory addresses are not constant in the model. This is why both filters have different syntaxes. A reference filter uses an inner qualifier to describe the kind of element that MapleMBSE is expecting to match. For the querying is as simple as the attribute filter, but there are some special cases to consider when initializing.

While querying with the following qualifier `[Property|type=[Class|name="block"]]`, the inner qualifier is helping to filter all Classes named block, and only Properties with a type reference to such classes would be displayed.

The reference filtering initialization has different behaviors depending on the type of reference. EReferences have properties of their own, like containment, multiplicity, and derived. Containment refers to the fact that a reference subsets ownership, for instance, packagedElement is a containment for Package, or slot is a containment for InstanceSpecification. Derived means that the value is a calculation of other attributes, ownedElement is a derived reference. Depending on which one of the reference filters is being used MapleMBSE would create a new element, refer to an existing one, or simply do nothing. Generally, if it is containment the filter initialization would create a new element, if it is derived the filter would not change a thing, and the rest of the time if there is a single element result of the inner qualifier in the whole model then a reference would be initialized to that Element. For example, let us revisit the previous qualifier `[Property|type=[Class|name="block"]]`, but this time during creation. The outer qualifier dictates what kind of Classifier is being instantiated, in this case a Property. The reference type is a non-containment, non-derived, and single valued reference; this means that the inner qualifier would try to find a single Class named block to fulfill the type reference while initializing the filter. If a unique Class named block exist in the model, then the newly created Property would be typed using a reference to that Class. Another example could be `[Class|ownedAttribute=[Port|type=[Class|name="block"]]]`, this illustrates how it is possible to nest filters. When creating a element with such qualifier, a Class would be instantiate and also a Port, this is due to the fact that ownedAttribute is a containment reference. Also, the Port that is created would be typed as mentioned before.

## 3.3 Predicate filter

A Predicate is a function that returns a boolean (true or false) value.

MapleMBSE uses predicates in the context of filtering.

The three steps involved in creating a predicate filter:

1. Defining the Predicate
2. Using the Predicate
3. Creating the Filter Logic for the predicate.

### Defining the Predicate

```
predicate hasnotype := NOT Port.type[Class]
```

### Creating the Filter Logic for the predicate

#### Unary Predicates

MapleMBSE predicates that take a single argument and return a boolean value.

#### NOT

The NOT predicate syntax is `NOT (Predicate)`.

For example, `NOT Port.type[Class]`

#### N-ary Predicates

MapleMBSE predicates that can take multiple arguments and return a boolean value.

#### OR, AND

The OR/AND syntax is: `[OR|AND] ( Predicate (; Predicate)+ )`

This means that either OR or AND can take multiple predicates as arguments, with each predicate separated by a semicolon.

#### OR1

This n-ary operations check that exactly 1 predicate is true in order to return true. The syntax is of the form:

```
OR1 ( Predicate (; Predicate)+ )
```

## Propositions

Unary and n-ary predicates do not query the model data. Those predicates delegate the matching to their children. Propositions, however, have no children and do query the model data. Proposition predicates are the leaves of the predicate tree. They are responsible for matching the data and the custom filter.

### Attribute Proposition

Using an EAttribute, this proposition can match a string to a value stored in the model. If multiple strings are given, they constitute an implicit OR. The syntax is of the form:

```
(EcoreImport::)?(EClassifier/)?EAttribute = value(,value)*
```

### Reference Proposition

Using an EReference, this proposition can match Qualifiers to the objects stored in the model. If multiple qualifiers are given, they constitute an implicit OR. The syntax is of the form:

```
(EcoreImport::)?(EClassifier [/ | .])? EReference Qualifier(,Qualifier)*
```

### Subset Proposition

Sometimes, MapleMBSE returns comma-separated list of strings, and instead of matching the same concatenated string, it would be better to perform the subset operation. For this subset proposition, the syntax would be of the form:

```
(EcoreImport::)?(EClassifier /)?EAttribute [SUBSET|SUPERSET] value(,value)*
```

### Inequality Proposition

SysML supports numeric basic types and MapleMBSE should be able to create predicates using those types. The most powerful way to take advantage of numeric values is with inequality operations of the form:

```
(EcoreImport::)?(EClassifier/)?EAttribute [=|!=|<|<=|>|>=]?
intValue
```

### Counting Proposition

There are times when a user wants to filter elements containing a specific amount of sub-elements. To accomplish this, use counting propositions of the form:

```
COUNT (EcoreImport::)?(EClassifier [/ | .])?EAttribute
[=|!=|<|<=|>|>=]? intValue
```

### Using the Predicate Filter

When using Predicate filtering, the predicate filter syntax should be:

`/qpe[Classifier| named_predicate]` where `/qpe` is the query path expression used to navigate from one element to another, in this case `/ownedAttribute`. Classifier, as mentioned earlier in this chapter is a type of element. In the example below, the Classifier is `Port`. The reference filter is `mse::metaclassName="MD Customization for SysML::additional_stereotypes::ConstraintParameter"`, followed by the attribute filter `aggregation="composite"` and finally the predicate filter, `hasnotype`.

```
dim /ownedAttribute[Port|mse::metaclassName="MD Customization for SysML::additional_stereotypes::ConstraintParameter", aggregation="composite",hasnotype]
```

## 3.4 The Sorting Feature

Thus far, you have seen how you can sort a table by mentioning the sort order in the worksheet template. During model load time, MapleMBSE will use Excel to sort the SyncView (table we see in a worksheet). In this section a new type of sorting is introduced, at the Qualifier level. This new sorting feature will sort elements that are received from the model and then send the data to Excel, where it displayed in the SyncView.

Note: The sorting that takes place in the worksheet template can be done only alphanumerically on the whole data source.

The new sorting mechanism can sort them by any common features of the Classifier (such as attributes, references) or Virtual Features (for instance, `elementType`). if you mention the sort order in the Qualifier and then also provide the sort-keys in the worksheet template, the sort-keys will be given preference.

### Defining the Sorting Feature

```
data-source elementsNew* [NamedElement | 1 | elementFilter | mse::elementType]
```

Where:

- `NamedElement` Can be any of Class, Activity, StateMachine, etc.
- `1` Refers to the index of the `NamedElement`.
- `elementFilter` Can be name, visibility, stereotype, etc.
- `mse::elementType` This is where sorting happens. In this case sorting is done using the `elementType` virtual feature.

### Using the Sorting Feature

For an example on using the Sorting feature, see chapter twenty of the MapleMBSE Applications Guide.



# 4 Query Path Expression

## 4.1 Query Path Expression Definition

Query Path Expression is an expression that queries the model for model elements and attribute values. It is used in defining Data Sources and SyncTable Schemas. The formal syntax definition is as follows.

QueryPathExpression	::=	( LocalQueryExpression )+ ( '@' ReferenceDecompositionId )?
LocalQueryExpression	::=	( ( '/' AttributeId )   ( '.' ReferenceId ) ) Qualifier?
AttributeId	::=	( EcoreImportId '::' )? <Attribute>
ReferenceId	::=	( EcoreImportId '::' )? <Reference>
Qualifier	::=	'[' ClassifierId ( ' ' AttributeFilter ( ',' AttributeFilter)* )? ']'
ClassifierId	::=	( EcoreImportId '::' )? <Classifier>
AttributeFilter	::=	AttributeId '=' ' "' <Expression> "'

ReferenceDecompositionId refers to ID of a ReferenceDecomposition defined in *ReferenceDecomposition and ReferenceQuery (page 46)*.

<Classifier>, <Attribute>, <Reference> refer to the corresponding UML elements, *Classifier*, *Attribute* and *Reference*. The names and their types are defined by a metamodel (via *EcoreImport (page 26)*). In Query Path Expressions we distinguish the following three types.

- **Classifier**  
A type of an element. For example, a UML model may have elements of type Class. Class is a Classifier. An element contains subelements which can be of two types: attributes and references.
- **Attribute**  
A subelement that belongs to the element.
- **Reference**  
A subelement that refers to another element.

To illustrate these types and their relations consider the example code below. The code is a snippet from the UML example model from the MapleMBSE User Guide.

**Tip:** The model file, *UserGuide.uml*, can be opened using any text editor. It can be found in the installation folder <MapleMBSE>/Example/UserGuide, where <MapleMBSE> is the location of your MapleMBSE installation.

```

...
<packagedElement xmi:type="uml:Class" xmi:id="_vXfqAM_MEee6666BhKb4Cg"
name="Class1">
  <ownedAttribute xmi:id="_AH4akdBoEee6666BhKb4Cg" name="Property1"
visibility="protected" type="tsYvoNBnEee6666BhKb4Cg" aggregation="shared"
association="AH3McNB0Eee6666BhKb4Cg">
    <lowerValue xmi:type="uml:LiteralInteger"
xmi:id="_AH4aktBoEee6666BhKb4Cg" value="1"/>
    <upperValue xmi:type="uml:LiteralUnlimitedNatural"
xmi:id="_AH5BoNB0Eee6666BhKb4Cg" value="1"/>
  </ownedAttribute>
  ...
</packagedElement>
<packagedElement xmi:type="uml:Class" xmi:id="tsYvoNBnEee6666BhKb4Cg"
name="Class2" visibility="private"/>
...
<packagedElement xmi:type="uml:Association"
xmi:id="AH3McNB0Eee6666BhKb4Cg" name="aggregation_class2_in_class1"...>
  ...
</packagedElement>
...

```

The text representation of the model is written in XML. The model and its content are represented by XML elements. An element can be defined as an empty element with attributes.

```
<element ... />
```

Or if it contains other elements it can be defined using the start and end tags.

```
<element> ... </element>
```

The classifiers are highlighted in blue: "uml:Class", "uml:LiteralInteger", "uml:LiteralUnlimitedInteger", "uml:Association". The "uml" namespace is defined in the definition of the Model element, see *Getting Started (page 1)*. Consider the ownedAttribute element Property1 in Class1. The attributes of the element are highlighted in green: name, visibility, aggregation, lowerValue, upperValue. The references of Property1 are highlighted in orange: type and association. You can see that the values of the references are the IDs of the elements they refer to.

The names of Classifiers, Attributes, and References can be written with or without EcoreImportId depending on how EcoreImport was declared. If there is only one EcoreImport in a configuration file and it was declared without an ID:

```
import-ecore "http://www.eclipse.org/uml2/5.0.0/UML"
```

EcoreImportId is not necessary. In this case, a query path expression that queries elements of a package can be written as follows.

```
/packagedElement
```

If an EcoreImport was declared with an ID:

```
import-ecore "http://www.eclipse.org/uml2/5.0.0/UML" as uml
```

`EcoreImportId` must be used to refer to classifiers, attributes, or references defined by the corresponding model. The same Query Path Expression takes the form.

```
/uml::packagedElement
```

In the following examples we omit `EcoreImportId`. The above examples of Query Path Expressions query all elements in a package. For the above example of a query path expression, it would include elements of types `Class` and `Association`. If we want to specify that only elements of `Class` type should be queried we need to specify a `Qualifier`:

```
/packagedElement[Class]
```

A `qualifier` can include one or more `FeatureFilters`. For example, to query a class inside a package called `Class1`, the following Query Path Expression can be used.

```
/packagedElement[Class|name="Class1"]
```

The examples we have considered so far consisted of single `LocalQueryExpressions`. `LocalQueryExpressions` can be combined to query nested objects. Each subsequent `LocalQueryExpression` applies to the result of the previous `LocalQueryExpression`. For example, to query attributes (the `ownedAttribute` elements) inside `Class1` inside a package, the following Query Path Expression can be used.

```
/packagedElement[Class|name="Class1"]/ownedAttribute
```

So far, we have only used attributes in query expressions. To query a type of an `ownedAttribute` in a class a `reference` must be used.

```
/packagedElement[Class|name="Class1"]/ownedAttribute.type
```

The result of the query is the element that the 'type' reference refers to. For `Property1`, it would return class `Class2`. Another way to specify a `reference` is to add the specification of `ReferenceDecomposition` at the end of the Query Path Expression.

```
/packagedElement[Class|name="Class1"]/ownedAttribute.type @  
ReferenceDecompositionId
```

`ReferenceDecomposition` is defined in Chapter 6, see *ReferenceDecomposition and ReferenceQuery (page 46)*. `ReferenceDecomposition` is a description of the referenced object. For display purposes there is no difference between a reference query with and without the use of `ReferenceDecomposition`. However, when updating a field specified by a reference without a `ReferenceDecomposition`, the updates apply to the referenced object. Whereas, with a `ReferenceDecomposition` the updates may change which object the reference points to. It is not recommended to use references without `ReferenceDecompositions`. If necessary, they should only be used in read-only worksheets.



## 5 Data Source

Data Source defines a set of model elements. A Data Source is combined with a SyncTable Schema to create a SyncTable for the model elements defined by the Data Source. The following is the formal definition of Data Source.

DataSource	:: =	PrimaryDataSource   ChainedDataSource
PrimaryDataSource	:: =	'data-source' (ID 'Root' 'ROOTS') '*'? Qualifier
ChainedDataSource	:: =	'data-source' ID '=' DataSource ObjectQueryExpression

Root is a reserved Data Source name that refers to the top-level model element. The type of the top-level model element depends on the type of a model. Definitions of the Root Data Source are based on the type of model, as shown in the *Root Data Source Definition (page 37)* table.

Type of Model	Root Data Source Definition
UML, SysML, Teamwork Cloud	<code>data-source Root[Model]</code>
Rhapsody	<code>data-source Root[REProject]</code>

A ChainedDataSource applies Query Path Expression to the result of the parent Data Source. Consider the example in the Figure below based on UserGuide.uml model (found in <MapleMBSE>/Example/UserGuide, where <MapleMBSE> is the MapleMBSE installation directory). The Figure *Figure 5.1 (page 37)* shows the relationship between the elements. For each element its classifier is given in italics. The elements enclosed in boxes with dashed lines are included in the corresponding data sources defined below.

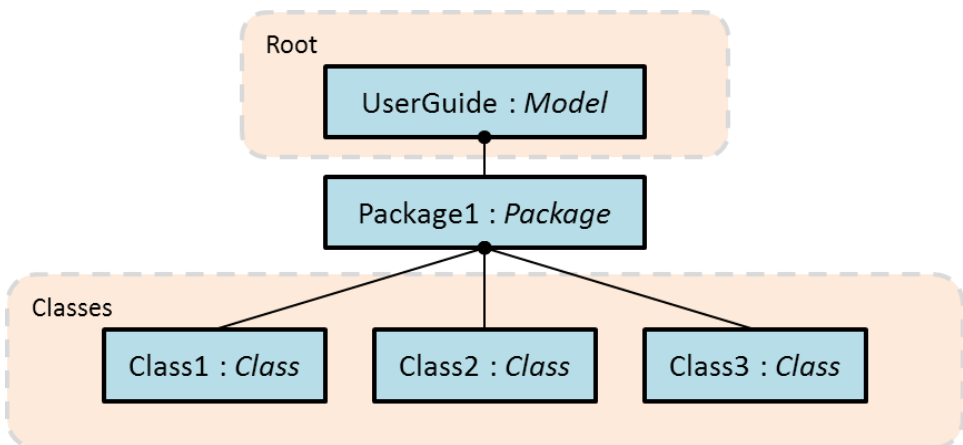

Figure 5.1: Relationship between model elements

- **Primary Data Source**

The example is a UML model, so the Primary Data Source is defined as follows.

```
data-source Root[Model]
```

In the code snippet above, the data-source retrieves the top-level element of the UML user model (user resource).

- **All Primary Data Source**

```
data-source classes*[Class]
```

In the code snippet above, the data-source retrieves all Classes regardless of their location inside the resource set. In other words, all Classes are retrieved, whether they are the model, or outside the model (for example, user resource, project resource, etc. or the model. In the example above Class1, Class2 and Class3 are retrieved.

This type of Primary Data Source is very useful, however, it should be used only to make read-only *SyncTable* (page 55) and *ReferenceDecomposition and ReferenceQuery* (page 46)reference-decomposition.

### Example for primitive DataTypes:

```
...
data-source allDataTypes*[DataType]
...
syncTable-schema DataTypesSchema {
  dta [DataTypes] {
    key column /name as typeName
  }
}

syncTable-schema PropertySchema(dts: DataTypesSchema) {
  dta [Property] {
    key column /name as propertyName
    reference-query .type @ typeRef
    reference-decomposition typeRef = dts {
      foreign-key column typeName as propertyType
    }
  }
}
...
syncTable dataTypeTable = DataTypesTable=allDataTypes
syncTable propertyTable = PropertySchema(properties(dataTypesTable))
...
```

- **Chained Data Source**

The following Data Source, called "classes", defines a set of all classes in Package1. It is defined by applying an Query Path Expression to a previously defined data source. In this case, the top-level data source, Root. In the example shown in *Figure 5.1* (page 37), Root is UserGuide.

```
data-source classes = Root/packagedElement[Package|name="Package1"]/packagedElement[Class]
```

## 6 SyncTable Schema

### 6.1 SyncTable Schema Definition

A SyncTable schema specifies how model elements are mapped to a logical table. With data sources explained in *Data Source (page 37)*, model elements are first organized as trees, and then mapped to tables. Such tree nodes are defined by *dimensions* in SyncTable schema, which identifies a model element by key columns. The formal syntax of SyncTableSchema is defined as:

```
SyncTableSchema      ::= 'syncTable-schema' ID ( '(' SyncTableParam ( ','
                               SyncTableParam ) * ')' )?
                               '{' TopLevelDimension  AbstractDimension* '}'
SyncTableParam       ::= ID ':' SyncTableSchemaId
TopLevelDimension    ::= ('record')? ('allow-empty')? 'dim' Qualifier '{'
                               DimensionMember* '}'
AbstractDimension    ::= SuccessiveDimension | DimensionGroup
SuccessiveDimension  ::= ('record')? ('allow-empty')? dim QueryPathExpression
                               '{' DimensionMember* '}'
DimensionGroup       ::= ('alternative'|'optional'|'group') '{'
                               DimensionMember* '}'
DimensionMember      ::= PropertyMapping | ReferenceDecomposition
PropertyMapping      ::= AttributeColumn | ReferenceQuery
AttributeColumn      ::= KeyAttributeColumn | NonkeyAttributeColumn
KeyAttributeColumn   ::= 'key' 'column' ObjectQueryExpression 'as' ID
NonkeyAttributeColumn ::= 'column' ObjectQueryExpression 'as' ID
```

where SyncTableSchemaId is ID of a SyncTableSchema, and TopLevelDimension appears first as defined in the formal syntax, and we need to put a qualifier to specify what model element types are selected, then SuccessiveDimension follows in which we put a Query Path Expression to query what model elements are selected as dimensions. In this chapter, we explain how to specify SyncTable schemas through examples.

## 6.2 Examples of SyncTable Schema

First, we show a simple SyncTable Schema as follows:

```

synctable-schema PkgCls {
  dim [REPackage] {
    key column /name as PkgName
    column /description as PkgDesc
  }
  record dim /nestedElements[REClass] {
    Key column /name as ClsName
  }
}

```

Here we define a SyncTable Schema with an ID called `PkgCls` and it consists of two Dimensions. `[REPackage]` in the top level dimension means it picks up `REPackage` model elements, and it must be consistent with that in data sources. The next dimension picks up `REClass` elements in `nestedElements` feature of the top level dimension. By applying this schema to **Pkg1**, **Pkg2** of the data source having **Figure 5.1**, we obtain two trees as shown in **Figure 6.1**, where **Pkg1** and **Pkg2** belong to the top level dimensions; and **Cls1** and **Cls2** belong to the next dimensions.

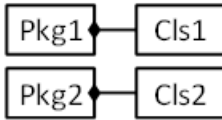

**Figure 6.1:** SimpleTree

## 6.3 Mapping the Attribute Values of the Model Elements to the Columns

The trees in the example above are translated into tables by the column definitions. The top level dimension has `PkgName` and `PkgDesc` columns, and they are filled with the QPEs of `/name` and `/description`, respectively. And the next dimension have `ClsName`



column, which is filled with the QPE of /name. Then the tree in **Figure 6.1** is translated to:

Pkg1	PkgDesc1	Cls1
Pkg2	PkgDesc2	Cls2

**Figure 6.2: SyncTable From Simple Tree**

More formally speaking, each path in the trees is translated into record, and then we have two records from the paths of **Pkg1-Cls1** and **Pkg2-Cls2**. Note that synctable schema determines all of the columns in a static way. They are, in this example, `PkgName`, `PkgDesc`, and `ClsName`, and the number is three.

## 6.4 Mapping the Dimensions to the Records

Let us look at how dimensions are mapped to records in more detail by comparing with the example below. The only difference from the previous example is the `record` keyword in the top level dimension highlighted with bold font.

```
synctable-schema PkgCls {
  dim [REPackage] {
    key column /name as PkgName
    column /description as PkgDesc
  }
  record dim /nestedElements[REClass]{
    key column /name as ClsName
  }
}
```

If any other conditions are the same as the above, the trees generated by this schema are exactly the same as in **Figure 6.1**. However, because the top level dimension has a `record` keyword, the table has more records as shown in **Figure 6.3**. The added records are the first and third rows, which come from the top level dimension. Note that the last dimension (in this example, that is the one corresponding to **Cls**) always creates records even if it is missing. In this table, the rightmost column in the first and third rows is specially treated as `EMPTY`. They will be shown as blank cells with light gray backgrounds, and distinguished from the usual blank cells

Pkg1	PkgDesc1	
Pkg1	PkgDesc1	Cls1
Pkg2	PkgDesc2	
Pkg2	PkgDesc2	Cls2

**Figure 6.3: SyncTable From Simple Tree (add record keyword to top level Dimension**

Note that each record corresponds to one model element. In this example, the first record corresponds to **Pkg1**, and the second one corresponds to **Cls1** while the previous example does not have any records corresponding to **Pkg1** nor **Pkg2**. Therefore, in this example you can add or delete packages by adding or removing a row while in the previous example you cannot. In this sense, record keyword plays a vital role that determines which model elements can be added or deleted by users.

## 6.5 Alternative and Group Dimensions

Next, we move on to how to organize tree structures by using the following example model. For the sake of simplicity, we denote model elements with lowercase with numbers (e.g. a1) and its types with uppercase (e.g. A) in this example.

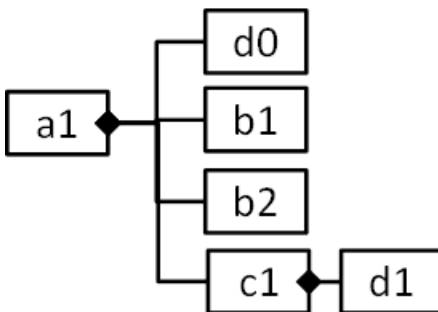

**Figure 6.4: Simplified Model Number Two: Using Alternative and Group**

Let us consider the following configuration:

```
synctable-schema alternativeExample{
  dim [A] {
    key column /name as Aname
  }
  alternative {
    record dim /nestedElements[B] {
      key column /name as Bname
    }
    record dim /nestedElements[C] {
      key column /name as Cname
    }
    record dim /nestedElements[D] {
      key column /name as Dname
    }
  }
}
```

It generates a tree as show in **Figure 6.5**.

The top level dimension selects type A by [A], and then the root of the tree is a1. In the following dimensions, it selects /nestedElements[B], /nestedElements[C], or /nestedElements[D] because these are in alternative { ... } clause. That means that if /nestedElements[B] is matched, the second dimension is used; if /nestedElements[C] is matched, the third dimension is used; and if /nestedElements[D] is matched, the forth dimension is used. Therefore, d0, the first model element in the nestedElements feature, is applied to the forth dimension; b1 and b2 are applied to the third dimension; and c1 is applied to the forth dimension. And then, we obtain a tree shown in **Figure 6.5**.

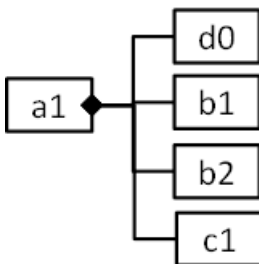

**Figure 6.5: Tree From Simplified Model Two**

This tree will be turned into a table as shown in **Figure 6.6**. It has four columns consisting of Aname, Bname, Cname, and Dname. Since the top level dimension does not have a

record keyword, it does not have a record of **a1**. Instead it creates four records for **b1**, **b2**, **c1**, and **d0** corresponding to the tree nodes under "a1" in **Figure 6.5**. Notice that the record for **c1** in the third row fills Aname and Cname columns, and Bname column is specially treated as VOID, which looks blank but filled with thick gray background. Likewise, the second (Bname) and third (Cname) columns in the fourth row are also filled with VOID.

a1	b1		
a1	b2		
a1		c1	
a1			d0

**Figure 6.6:** Table Made From The Tree of Simplified Model Two

Let us move on to the next example using `group` as shown below:

```
synctable-schema groupExample {
  dim [A] {
    key column /name as Aname
  }
  alternative {
    record dim /nestedElements[B] {
      key column /name as Bname
    }
    group {
      dim /nestedElements[C] {
        key column /name as Cname
      }
      record dim /nestedElements[D] {
        key column /name as Dname
      }
    }
  }
}
```

It generates a tree as shown in **Figure 6.7**.

The difference is that now **d1** belongs to **c1** instead of **a1** because the above configuration says B or C followed by D rather than B, C, or D. It means something like (B or (C, D)) in contrast with (B or C or D). That is, `group` keyword is something like parentheses in dimension definitions and `alternative` is like the `or` operator.

Then this tree is translated to a table as shown in **Figure 6.8**. Since the dimensions of B and D have a record keyword, it creates three records: **b1**, **b2**, and **d1**, corresponding to the first, second, and third rows. The third and fourth columns that follow after **b1** and **b2**, in the first and second rows, are EMPTY and the second column in the third row is VOID in this table.

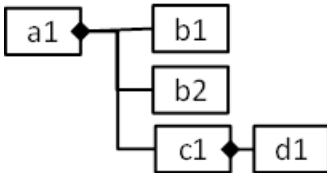

**Figure 6.7: Another Tree Made From Simplified Model Two**

a1	b1		
a1	b2		
a1		c1	d1

**Figure 6.8: Another Table Made From Simplified Model Two**

Since group keyword combines dimensions in alternative blocks, using it out of alternative does not give any effects. For example,

```

dim ... {}
dim ... {}
dim ... {}
  
```

and

```

dim ... {}
group {
  dim ... {}
  dim ... {}
}
  
```

give the same results.

## 6.6 ReferenceDecomposition and ReferenceQuery

### Mapping reference values with ReferenceDecomposition and ReferenceQuery

`ReferenceDecomposition` is used for presenting references of model elements. The examples so far edit model elements themselves by querying them with QPEs, where we can track references as well. That means we always change values of such model elements instead of references to model elements.

First we specify the formal syntaxes of `ReferenceDecomposition` and `ReferenceQuery` as below:

```
ReferenceQuery      ::= ('key')? 'reference-query' ObjectQueryPath
ReferenceDecomposition ::= 'reference-decomposition' ID '='
                    [ReferrableSyncTable] '{' ForeignColumn* '}'
ForeignColumn      ::= KeyForeignColumn | NonkeyForeignColumn
KeyForeignColumn   ::= 'foreign-key' 'column' [Column] 'as' ID
NonkeyForeignColumn ::= 'foreign' 'column' [Column] 'as' ID
```

In `ReferenceDecomposition`, you should specify all of the key columns in the referred table as `KeyForeignColumn` (that is, you should specify "foreign-key" for such key columns) because we should identify a record by such key columns. If the configuration does not satisfy this condition, it is not guaranteed to identify a unique record to make a reference.

### ReferenceDecomposition by Example

We use the following code snippet to explain `ReferenceDecomposition`.

This configuration transforms the target model in **Figure 6.9** into a table as shown in **Figure 6.10**.

This example first introduces the `TypesByName` `synctable-schema`, which itemizes all of the types as `TypeName`, and `AttsByName` refers to that type by the `type` feature of `REAttribute`. Note that `AttsByName` takes the `tps` argument of `TypesByName`, and in Line 7, the `attributes` `synctable` takes `types` as an argument and then the `attributes` `synctable` uses `types` `synctable` to refer to types by the `ReferenceDecomposition` in Lines 25-28. Let us look into these in the following section.

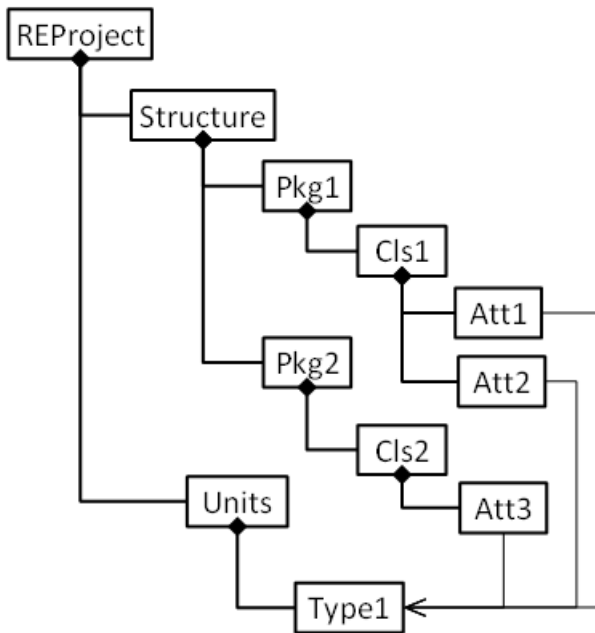

Figure 6.9: Target Model

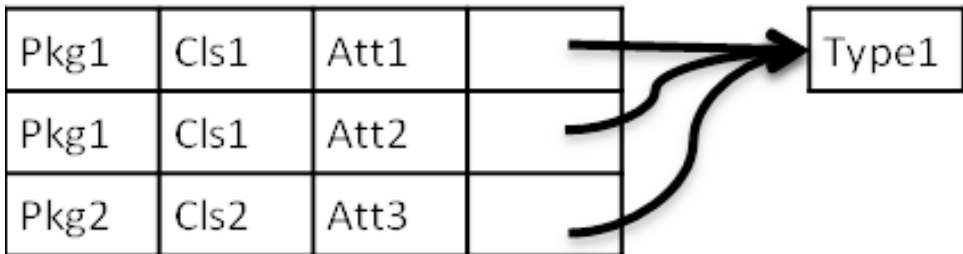

Figure 6.10: Illustration of ReferenceDecomposition

### Adding a Missing Target Element: the create-target Keyword

If the target element exists, then while doing the reference decomposition, MapleMBSE can refer to that element. However, if the target element does not exist, then while doing the reference decomposition you will see an error message indicating that MapleMBSE was unable to resolve the reference. At this point, you would need to create the element in the appropriate schema.

To avoid having to go into the schema to create the element, you can add the `create-target` keyword in the reference decomposition. In this case, while doing the reference decomposition, if MapleMBSE cannot find the element, it will create that element.

The following MSE example illustrates how to use the `create-target` keyword within a reference decomposition.

```
reference-decomposition cls3 = blocks {
  create-target
  foreign-key column BlockName as Name3
}
```

**Note:** If you refer to an element in a schema, but while typing make mistake, MapleMBSE will create that element in the model. To correct this, delete the element in the schema or MagicDraw.

## References by Dimensions or ReferenceQuery

Next, let us see how we identify references. As show in Line 25 of

(page 46).

, we write `reference-query QPE @ name` in the dimension. Let us look in the part in the example of the previous section:

```
23 dim /nestedElements[REAttribute] {
24     key column /name as AttName
25     reference-query .type @ typedecomp
26     reference-decomposition typedecomp = tps {
27         foreign-key column TypeName as Type
28     }
29 }
```

In this example, we use the `type` feature of `REAttribute` as a reference to be decomposed. Thus, this reference refers to a type identified by the `TypeName` column of `tps` table. This dimension has `AttName` and `Type` columns and `AttName` column is associated with `name` feature of `REAttribute` of this dimension, and `Type` column is used to refer to `type` (see the `reference-query`) by `TypeName` column of `tps` table.



Otherwise, if the reference is associated with a dimension, we put @ name after the dimension definition as the example below:

```
dim [REInstance] { .. }
dim .otherClass[REClass] @ cls2 {
  reference-decomposition cls2 = clsTbl {
    foreign-key column PkgName as PkgName2
    foreign-key column ClsName as ClsName2
  }
  column /description as ClsDesc2
}
```

where we use `cls2` as the name of the reference. And in the following `reference-decomposition cls2`, we use `PkgName` and `ClsName` columns of `clsTbl` to present that reference. Therefore, this dimension has `otherClass` reference of `REInstance` (in the previous dimension), which refers to `REClass` class identified by `PkgName` (propagated by `PkgName2` column of this dimension) and `ClsName` (propagated by `ClsName2` column, likewise) columns of `clsTbl`. Note that `clsTbl` is a parameter of the `syncatable-schema`. Since `PkgName` and `ClsName` are key columns, we specify the `foreign-key` keyword in the reference decomposition. In addition, we can edit description of the reference via `ClsDesc2`.

## 6.7 Key Columns Defined in SyncTable Schema

In a `syncatable-schema`, we need to specify key columns to identify the recode by such key columns. So in every dimension, we need at least one key column and all of the model elements associated with this dimension must be uniquely identified by the defined key columns. Key columns in dimensions are one of the followings:

1. Columns defined by **key** column
2. All of `foreign-key` columns in the `ReferenceDecomposition` that uses references by **key** `reference-query` or dimensions. If you use `reference-query` without the `key` keyword, such `foreign-key` columns are not key columns.
3. Generally speaking, all of the foreign keys must have a non-empty value except if they have a dimension that supports empty values.

## 6.8 The allow-empty Option

When using the Optional dimension keyword in a table view a user can relate the different successive dim to the last dim but this is not the case with the Matrix View. In the Matrix view when referencing a synctable-schema with Optional dimensions the last dim in the current table will be related only to the last dim in the table that is referenced. Using allow-empty will create the desired functionality similar to the table view.

In general, foreign keys don't accept empty values unless you use the allow-empty option.

You must use allow-empty in Reference Decomposition. Use in the dimension that contains the reference decomposition with possible empty values.

```
//Table to be referenced
synctable-schema BlocksTable {
  dim [Class|mse::metaclassName="SysML::Blocks::Block"] {
    key column /name as bName1
  }
  optional {
    allow-empty dim /mse::getAllProperties[Property
|mse::metaclassName="MD Customization for SysML::additional_stereotypes::PartProperty"]
    .mse::directedAssociatedProperty[Class] {
      key column /name as bName2
    }
  }
  dim /mse::getAllProperties[Property] {
    key column /name as valName
  }
}

synctable-schema InstanceTable(blk : BlocksTable){
  record dim [InstanceSpecification] {
    key column /name as instanceName
  }
  //referencing optional dims from previous table
  allow-empty dim /mse::slots[Slot] {
    key reference-query .definingFeature[Property] @ dfRef
    reference-decomposition dfRef = blk {
      foreign-key column bName1 as bName1
      foreign-key column bName2 as bName2
      foreign-key column valName as valName
    }
    column /mse::slotValue as cValue
  }
}
```

## 6.9 Using Default Value Generation in a Column

After you assign a name to Attribute Column use '=' and then enter the type of value you want to generate, as in the example below. Here the attribute column has been assigned the name PropertyName, followed by '=', then the text value and Sequence number .

```

synctable-schema BlockSchema {
  record dim [Package] {
    | key column /name as packageName
    | column /visibility as pkgVis = "private"
  }

  record dim /packagedElement[Class|mse::metaClassName="SysML::Blocks::Block"] {
    key column /name as blockName = %UUID
  }

  dim /ownedAttribute[Property]{
    key column /name as propertyName = "R" %SEQID
  }
}

```

## Limitations

Default value generation column doesn't work in the following cases:

- In root dimension key column
- In alternative, group, optional key columns

## Data Insertion Order with the Default Column

If you have default value generation in the sync scheme then order to enter information into the cells is important here let's see the example We have a scheme in which record root dimension is package and visibility, visibility has default value next we have record dimension for Class which has default value generation after that we have record dimension for the property.

```

synctable-schema BlockSchema {
  record dim[Package]{
    key column /name as packageName
    column /visibility as pkgVis="private"
  }
  record dim /packagedElement[Class|mse::metaClassName="SysML::Blocks::Block"]
  {
    key column /name as blockName=%UUID
  }
  record dim /ownedAttribute[Property]{
    key column /name as propertyName = "R" %SEQID
  }
}

```

### Example: Create a Package that has Class and Property

This example illustrates the importance of the order of entry of data with default value generation.

1. Enter the Package name. From the table below you can see that the Visibility has been automatically created.
2. Enter the same Package name again. Notice the Class column has been automatically filled.
3. Next, try to create the property by entering the package name. Notice that MapleMBSE creates a new Class. If you repeat this, MapleMBSE will create a another new Class.
4. This time, enter the Class name first.
5. Next, enter the Package name. Notice that a property has been created.

Package	Visibility	Class	Property
Package	private		
Package	private	beaaefaf-e74b-41c7-8502-b72989b72f2b	
Package	private	2e664310-7a99-4df7-9ddb-f9c7559e4048	
		2e664310-7a99-4df7-9ddb-f9c7559e4048	
Package	private	2e664310-7a99-4df7-9ddb-f9c7559e4048	R1

### Example: Create a Package and Class with Alternative Dimensions

In this example, a second dimension has default values but not a record dimension. After that, there are alternative two dimensions.

```

synctable-schema B2Schema {
  record dim [Package] {
    key column /name as packageName
  }

  dim /packagedElement[Class] {
    key column /name as blockName =%UUID
  }
  alternative{
    dim /ownedAttribute[Port]{
      key column /name as portName
      column /visibility as pVis
    }

    dim /ownedAttribute[Property]{
      key column /name as propertyName
      column /visibility as proVis
    }
  }
}

```

1. Enter the Package name. The Class and other fields are grayed-out so the package has been created.
2. Enter the Package name again. Notice the Class was not created, as shown in the image below.

Package	Class	port	visibility	Property	Visibility
Package					
Package					

3. To create the Class and visibility, you have to enter the Property or port name. After this, the Class will be created as shown below.

Package	Class	port	visibility	Property	Visibility
Package					
Package	7e53a36b-63ba-4c68-8b72-cbe4f0c19d4d	port	public		

## Using Default Value Generation to create Requirement IDs

The default value generation feature has been extended to include Requirements ID (REQID) generation. This means you can use value generation to

added generated Requirements IDs to MapleMBSE. The general syntax is as follows:

```
synctable-schema RequirementsTable {
    record dim
    [Class|mse::stereotypeNames="SysML::Requirements::Requirement"] {
        key column /name as Name
        column
        /taggedValue[StringTaggedValue|mse::featureName="SysML::Requirements::AbstractRequirement::Id"]/value
        as ID = %REQID
        column
        /taggedValue[StringTaggedValue|mse::featureName="SysML::Requirements::AbstractRequirement::Text"]/value
        as Specification
    }
}
```

where "= %REQID" instructs MapleMBSE to check the modeling tool for the latest IDs, validate these IDs, and add them to the MapleMBSE worksheet.

## 7 SyncTable

A `SyncTable` is an intermediate structure created in the first step of converting model data into a table from shown in an Excel spreadsheet. The definition of a `SyncTable` consists in applying a `SyncTable` schema to a `Data Source`. The formal syntax of a `SyncTable` definition is as follows.

```
SyncTable ::= 'synctable' ID '=' SyncTableSchemaId '<' DataSourceId  
'>' ( '(' SyncTableId (',' SyncTableId)* ')' )?
```

In the table `'synctable' ID '=' SyncTableSchemaId '<' DataSourceId '>' ( '(' SyncTableId (',' SyncTableId)* ')' )?` (page 55).

`SyncTableSchemaId` is an ID of a `SyncTableSchema`.

- `DataSourceId` is an ID of a `DataSource`.
- `SyncTableId` is an ID of a `SyncTable`.





## 8 Laying out SyncViews

This chapter describes how SyncTables are presented as SyncViews. All of the SyncViews must be laid out in some worksheet in a workbook. The rest of the sections are organized as 1) how to set up worksheets in a workbook; 2) how to lay out SyncTables in a table; and how to lay out SyncTables in a matrix.

### 8.1 Setting up a Workbook and Worksheets

When MapleMBSE opens a model, it assigns one workbook to the model, and in *Workbook Instance*, we specify all of the worksheets managed by MapleMBSE. In each configuration, one and only one Workbook instance must be specified.

The example below comes from **Example/UserGuide.MSE**, and it defines all of the worksheets.

```
workbook {
  worksheet AllElements(allElementsTable)
  worksheet PackageClassProperty(classesInPackage) {label = "NestedElements"}
  worksheet PackageClass(classesTable)
  worksheet Horizontal(classesInPackage) {label = "HorizontalTable"}
  worksheet Dependencies(dependenciesTable, dependentTable, supplierTable) {label = "Matrix"}
  worksheet DependenciesSheet(dependenciesTable)
  worksheet Packages(packagesTable)
  worksheet NestedPackageClass(nestedPackageClassTable) {label = "AlternativeGroups"}
  worksheet UnmappedFields(nestedPackageClassTable)
}
```

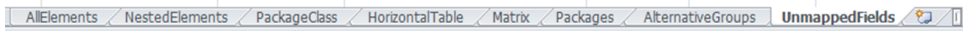

In the example shown “workbook” is used to represent the arrangement of worksheets as shown, *AllElements* is the name of the worksheet template and *allElementsTable* is the name of the syncTable that is created. By default, a worksheet is created with the name *AllElements* containing the information from the corresponding worksheet-template. MapleMBSE allows the user to create a name for the worksheet manually by using the ‘label’ attributes as shown in the above example.

**Note:** When a worksheet template is created with more than one parameter they should be separated with ‘,’ as shown above for the creating a *Dependencies* worksheet.

If *lazy-load* is specified before *worksheet*, MapleMBSE will load syncviews of that worksheet when that worksheet is activated. By default, they are loaded at the startup and then the name of *worksheet-template* and its parameters follow. This means the worksheet will be defined by the specified *worksheet-template*. The details of *worksheet-template* are explained in the next section.

If the worksheet declaration has *label="XXX"*, MapleMBSE regards "XXX" as the name of the worksheet. Otherwise, the name, *worksheet-template* is used as the name of the worksheet. For example, *AllElements* will be the name of the worksheet defined by

`worksheet AllElements(allElementsTable)`. If the Excel template has the worksheet with the same name, MapleMBSE will use this worksheet to initialize the syncviews of `worksheet-template`. Otherwise, MapleMBSE will create a new worksheet with the same name.

## 8.2 Worksheet Template and View Layout

A worksheet template is used to define how a SyncTable should be represented in the Excel worksheet. In a worksheet template, we can specify one or more `ViewLayouts`, each of which can be a table view layout or a matrix view layout, in the following subsections respectively.

The formal syntax of worksheet template is as follows.

```
WorksheetTemplate ::= 'worksheet-template' ID '(' WorksheetTemplateParam
                    (' WorksheetTemplateParam)* ')'
                    '{ ViewLayout* }'
ViewLayout        ::= TableViewLayout | MatrixViewLayout
```

where ID means the name of the worksheet template and should be referred by worksheet definitions explained in the previous section.

**Important:** Do not use an *All Primary Data Source* (page 38) directly in the workbook as `WorksheetTemplateParam`;

### Table View Layout

Table view layout allows the user to define how the contents of the model should be displayed in the table. It has two possible arrangements: vertical or horizontal. The syntax for table view layout is as show above. To define a table layout: you must specify the arrangement of the table, the cell address to define the location of table in Excel, and the order of the fields. A column can be populated with either mapped or unmapped fields; a mapped field displays the attributes or value assigned to it whereas an unmapped field is used to insert a blank column within the table. Based on how fields are declared in the sync table schema as key column or column inside the view layout they are declared as key field or field respectively. It is necessary to provide the column type as string or integer for every field that is created except for the unmapped field.

The formal syntax of table view layouts is as follows.

```
TableViewLayout ::= ('vertical' | 'horizontal') 'table' ID at '
                  CellAddr
                  '=' WorksheetTemplateParam '{'
                  ( 'import-order' INT )? & ( 'enable-import'
```

```

                                BoolType )?
                                ViewColumn*( SortKeys )? }'
ViewColumn      ::= MappedViewColumn | UnmappedViewColumn
MappedViewColumn ::= KeyViewColumn | NonkeyViewColumn
KeyViewColumn   ::= 'key' `ref'? 'field' [KeyColumn] ':'
                                ViewColumnType
NonkeyViewColumn ::= `ref'? 'field' [Column] ':' ViewColumnType
UnmappedViewColumn ::= 'unmapped-field'
ViewColumnType  : ('String' | 'Integer' | 'Double')'[]'? (';'
                                'delimiter' '=')? & (';' 'quote' '=' STRING)?

```

The following code snippet comes from **UserGuide.MSE** which defines a table view layout.

```

worksheet-template AllElements(cls:AllElementsTable) {
  vertical table tab1 at (3,2) = cls {
    key field PackageName : String
    field PackageVisibility : String
    key field TopClassName : String
    field TopVisibility : String
    key field PropertyName : String
    field PropertyVisibility : String
    field AggType : String
    field PropertyTypePackage : String
    field PropertyType : String
    field PropertyTypeVisibility : String
    sort-keys PackageName, TopClassName, PropertyName
  }
}

```

In the example shown above, a worksheet template with ID `AllElements` is created for a `synctable-schema`, `AllElementsTable` that is assigned to a parameter `cls`. Line 2 defines that the table is arranged vertically and `(3, 2)` means it should be displayed from Row 3 and Column B in Excel as show in the figure below. Line 3 to line 12 in the example defines the order in which fields have to be displayed in Excel, shown as Table View in the figure. In line 3 in the sample, `key field` is used for `PackageName` because it was specified as `key column` in the `synctable schema` for `AllElementsTable`. Column type for every field is provided as shown from line 3 to line 12, in the example shown `String` is the type for all fields. To specify type `integer`, use `Int` instead of `String`. `sort-keys` are used to indicate the columns that should be sorted in ascending order when model data is loaded or when new data is added to the table. Predefined Row in the figure below denotes that the Excel sheet can be formatted based on user preference before the model is loaded in the Excel sheet.

Package Name	Package Visibility	Class Name	Class Visibility	Property Name	Property Visibility	Aggregation Type	Property Type Package	Property Type	Type Visibility
Package1	public								
Package1	public	Class1	public						
Package1	public	Class1	public	Property1	protected	shared	Package1	Class2	private
Package1	public	Class1	public	Property2	public	composite	Package1	Class3	public
Package1	public	Class2	private						
Package1	public	Class3	public						

### Matrix View Layout

A matrix view layout consists of three parts, row index table view part, column index table view part, and matrix part, as shown in the following example:

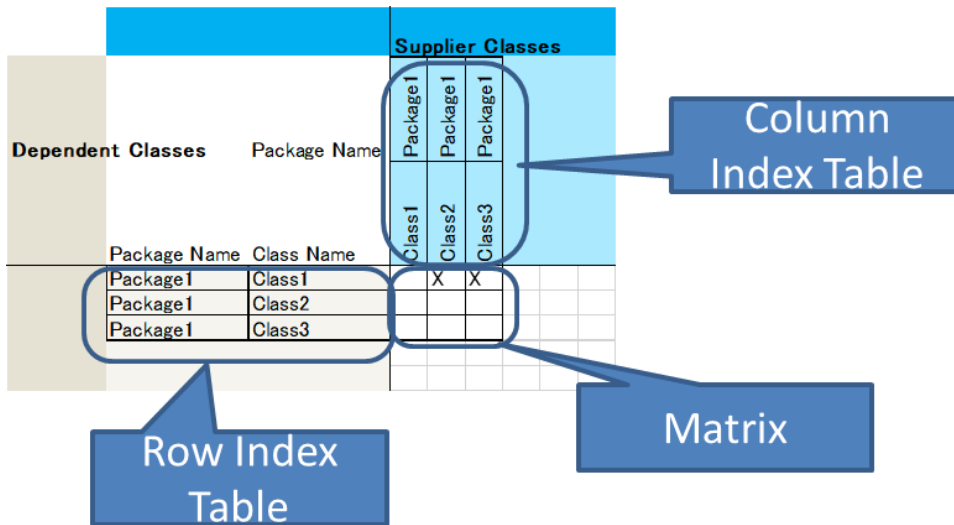

The formal syntax of matrix view layout is as follows.

```

MatrixViewLayout ::= 'matrix' ID 'at' CellAddr
                  '=' [WorksheetTemplateParam] '{'
                    ( 'import-order' INT )? &
                    ( 'enable-import' BoolType )?
                  ViewColumn
    
```

```

MatrixRowIndexViewLayout &
MatrixColumnIndexViewLayout

}'

MatrixRowIndexViewLayout ::= 'row-index' '=' [WorksheetTemplateParam]
                              {' ViewColumn* ( sortKeys=SortKeys )?
                              }'

MatrixColumnIndexViewLayout ::= 'column-index' '='
                                [WorksheetTemplateParam]
                                {' ViewColumn* ( sortKeys=SortKeys )?
                                }'

```

Row and column index tables identify which cell in a matrix should be selected to show a record of the synctable. The following code snippet comes from **UserGuide.MSE** which defined matrix view layout.

```

1 worksheet-template Dependencies(mat:DependenciesTable,tabr:DependentTable,tabc:SupplierTable) {
2   matrix Matrix1 at (5,4) = mat {
3     const-field "X"
4     row-index = tabr {
5       key field DependentPackageName : String
6       key field DependentClassName : String
7
8       sort-keys DependentPackageName, DependentClassName
9     }
10    column-index = tabc {
11      key field SupplierPackageName : String
12      key field SupplierClassName : String
13
14      sort-keys SupplierPackageName, SupplierClassName
15    }
16  }
17 }

```

In this example, Lines 2 to 16 defines matrix layout with the name of `Matrix1` created by `mat`, that is `DependenciesTable` (see parameters of `Dependencies`). `const-field` means a matrix cell should be filled with the specified value if and only if the corresponding record exists. You can specify some column instead of `const-field`. For example, if you specify field `DepName : String`, you can edit `DepName` in matrix cells. However, you can specify only one field for a matrix view layout.

Lines 4 to 9 define a row index table, and Lines 10 to 15 define a column index table. Using this configuration, `DependentTable` (row index table) needs to have `DependentPackageName` and `DependentClassName` columns, and `SupplierTable` (column index table) needs to have `SupplierPackageName` and `SupplierClassName` columns, and finally, `DependenciesTable` (matrix table) needs to have all of the columns, those are `DependentPackageName`, `DependentClassName`, `SupplierPackageName` and `SupplierClassName`.

Name, and `SupplierClassName`. In **DependenciesSheet**, we can show `DependenciesTable` in a vertical table as below:

Dependent Classes		Supplier Classes	
Package Name	Class Name	Package Name	Class Name
Package1	Class1	Package1	Class2
Package1	Class1	Package1	Class3

A synctable used to present in a Matrix **must have** all of the same key columns of row and column index tables. In this example, `DependenciesTable` (synctable to be shown in a matrix) must have `DependentPackageName` and `DependentClassName` that are the key columns of row index table (`DependentTable`), and `SupplierPackageName` and `SupplierClassName` that are key columns of column index table (`SupplierTable`). Notice that all of the column names must be unique.

## 8.3 Making Worksheets Read-only

You can make any worksheet in the workbook ready-only:

1. Right-right click on the worksheet tab at the bottom of the worksheet.

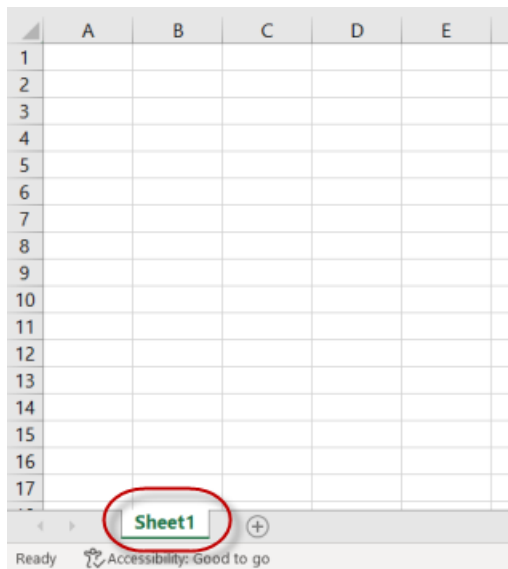

2. From the context menu, select **Protect Sheet**.

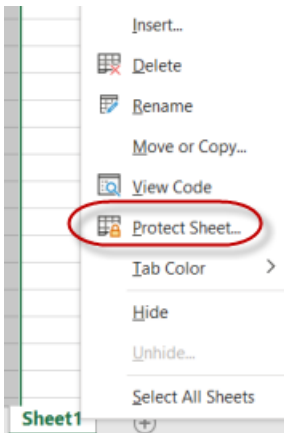

3. Leave password field blank and click **Ok**.





# 9 Capella Example

## 9.1 Sample MSE File for a Capella Model

Based on the QPE context explained in the previous chapters, you will develop an example configuration file to query the logical functions of the In-flight entertainment sample.

Capella has multiple ecores for the different architectural layers. It is always good practice to include all the ecore even if you are not using it your MSE file. A main advantage with Capella MSE file is since the model structure is maintained the same you can create MSE files that will work with different projects without the need to update it.

To create the MSE file you can use either:

- The MapleMBSE eclipse editor
- A text editor to create a configuration file.

**Note:** The process for creating the content in the MSE file is the same, regardless of how you created the MSE file.

### Create the MSE File in the Eclipse Editor

If you are using the eclipse editor:

1. Select the File menu.
2. Select New Project(General Project)
3. Click New.
4. Enter a name with extension .MSE
5. Click Ok.

Note: You can use `Ctrl + Space` for auto-suggestions.

### Create the MSE File in a Text Editor

If you are using a text editor:

1. Select the File menu.
2. Select New
3. Select Text Document
4. Enter a name and extension .MSE

## ecore Import

First step in any MSE file is to mention the ecores we are using to query the model. For the Capella model using the following ecore import.

```
import-ecore "http://www.polarsys.org/capella/core/modeller/1.4.0"
import-ecore "http://www.polarsys.org/capella/core/ctx/1.4.0" as sa
import-ecore "http://www.polarsys.org/capella/core/la/1.4.0" as la
import-ecore "http://www.polarsys.org/capella/core/cs/1.4.0" as cs
import-ecore "http://www.polarsys.org/capella/core/information/1.4.0" as info
import-ecore "http://www.polarsys.org/capella/core/core/1.4.0" as core
import-ecore "http://www.polarsys.org/capella/core/oa/1.4.0" as oa
import-ecore "http://www.polarsys.org/capella/core/fa/1.4.0" as fa
import-ecore "http://www.polarsys.org/capella/core/pa/1.4.0" as pa
```

## Data Source

To get the top level logical functions you need to define the data-source up to the Root Logical Function. The best way to identify the queries is to use a sample model's melody modeler file. Open the melody modeler file in a text editor. This will help identify the path and queries easily.

```
<ownedModelRoots xsi:type="org.polarsys.capella.core.data.capellamodeller:SystemEngineering"
  id="8249452a-61f2-4ba0-b944-352d1f4c4227" name="In-Flight Entertainment System"
  description="Operational Analysis" <strong>Operational Analysis</strong>
  <ownedExtensions xsi:type="re:RecCatalog" id="1ca39c3f-c7e3-40cc-96b7-31c19a7b3b2d"
    name="Catalog">
    <ownedArchitectures xsi:type="org.polarsys.capella.core.data.oa:OperationalAnalysis"
      id="e12de7af-bf77-4c43-9f7c-03404be33a29" name="Operational Analysis">
    <ownedArchitectures xsi:type="org.polarsys.capella.core.data.ctx:SystemAnalysis"
      id="1d10b78a-f222-4794-9f78-5b70ce799bf0" name="System Analysis">
    <ownedArchitecture xsi:type="org.polarsys.capella.core.data.la:LogicalArchitecture"
      id="c8b89820-127c-4d24-bfe7-31b2000cc23c" name="Logical Architecture" description="">
    <ownedArchitecture xsi:type="org.polarsys.capella.core.data.pa:PhysicalArchitecture"
      id="9a0668cf-db26-4ee7-9339-c1d8658fa112" name="Physical Architecture">
    <ownedArchitecture xsi:type="org.polarsys.capella.core.data.epbs:EPBSArchitecture"
      id="7c142d0f-dd8e-4539-bcb5-3ea9c2fd59d" name="EPBS Architecture">
  </ownedModelRoots>
/org.polarsys.capella.core.data.capellamodeller:Project>
```

From the screenshot, notice that the In-Flight Entertainment System has ownedModelRoots which contains different architectural layers. One of which is LogicalArchitecture.

The project has ownedModelRoots which are of model element type SystemEngineering. The SystemEngineering package has ownedArchitectures which will give us all five layers. This examples is only concerned with the logical architecture and

hence using the LogicalArchitecture classifier will get models elements from this specific layer.

Add a data source to your MSE file that starts from Root to LogicalArchitecture.

```
import-ecore "http://www.polarsys.org/capella/core/modeller/1.4.0"
import-ecore "http://www.polarsys.org/capella/core/ctx/1.4.0" as sa
import-ecore "http://www.polarsys.org/capella/core/la/1.4.0" as la
import-ecore "http://www.polarsys.org/capella/core/cs/1.4.0" as cs
import-ecore "http://www.polarsys.org/capella/core/information/1.4.0" as info
import-ecore "http://www.polarsys.org/capella/core/core/1.4.0" as core
import-ecore "http://www.polarsys.org/capella/core/oa/1.4.0" as oa
import-ecore "http://www.polarsys.org/capella/core/fa/1.4.0" as fa
import-ecore "http://www.polarsys.org/capella/core/pa/1.4.0" as pa

data-source Root[Project]
data-source architectures = Root/ownedModelRoots[SystemEngineering]/ownedArchitectures[la::LogicalArchitecture]
```

Next, add another data-source called logicalfunctions to query the logical functions.

```
import-ecore "http://www.polarsys.org/capella/core/modeller/1.4.0"
import-ecore "http://www.polarsys.org/capella/core/ctx/1.4.0" as sa
import-ecore "http://www.polarsys.org/capella/core/la/1.4.0" as la
import-ecore "http://www.polarsys.org/capella/core/cs/1.4.0" as cs
import-ecore "http://www.polarsys.org/capella/core/information/1.4.0" as info
import-ecore "http://www.polarsys.org/capella/core/core/1.4.0" as core
import-ecore "http://www.polarsys.org/capella/core/oa/1.4.0" as oa
import-ecore "http://www.polarsys.org/capella/core/fa/1.4.0" as fa
import-ecore "http://www.polarsys.org/capella/core/pa/1.4.0" as pa

data-source Root[Project]
data-source architectures = Root/ownedModelRoots[SystemEngineering]/ownedArchitectures[la::LogicalArchitecture]
data-source logicalFunctions = architectures/ownedFunctionPkg[la::LogicalFunctionPkg[name="Logical Functions"]
/ownedLogicalFunctions[la::LogicalFunction[name="Root Logical Function"]]/ownedFunctions[la::LogicalFunction]
```

At this point you can continue with the queries until you reach the logical functions or you can break down the data source so you can reuse a top level data source when necessary.

If you expand LogicalArchitecture in the text editor you will see that logical functions are in a package called Logical Functions. Root Logical Function is contained in the functions package which contain other logical functions.

## synctable-schema

Start the synctable-schema based on the data-source you want to link it. In this case, start the data source with logical functions.

Use record before the dim since you will want unique information to be displayed in a single row in Excel.

Use name as the unique identifier.

```

synctable-schema LogicalFunctionsSchema {
  record dim [la::LogicalFunction]{
    key column /name as logicalFunction
  }
}

```

The model has four level of subfunctions so you need to add four `dim` levels which will display respective subfunctions. The top level logical function owns the sub level and etcetra.

```

synctable-schema LogicalFunctionsSchema {
  record dim [la::LogicalFunction]{
    key column /name as logicalFunction
  }
  record dim /ownedFunctions[la::LogicalFunction]{
    key column /name as subFunctionL1
  }
  record dim /ownedFunctions[la::LogicalFunction]{
    key column /name as subFunctionL2
  }
  record dim /ownedFunctions[la::LogicalFunction]{
    key column /name as subFunctionL3
  }
  record dim /ownedFunctions[la::LogicalFunction]{
    key column /name as subFunctionL4
  }
}

```

The above queries will display a tree structure in Excel starting from the top level.

Now that the `data-source` and `synctable-schema` are defined, they now have to be linked.

Add the following line to your MSE file to create a synctable called **logicalFunctionsTable**.

```

synctable logicalFunctionsTable = LogicalFunctionsSchema<logicalFunctions>

```

## Worksheet Template

In this step, define the order of the columns, the table placement and the kind of table you want to display.

Create a template to display a vertical table that starts from row three and column four.

You should also specify the schema for which the template is defined.

```

worksheet-template FunctionsTable( lfs : LogicalFunctionsSchema){
  vertical table tab1 at (4,5) = lfs{
    }
}

```

Based on the columns defined in the `LogicalFunctionsSchema`, order the columns and sort based on top level function and second level function.

```

worksheet-template FunctionsTable( lfs : LogicalFunctionsSchema){
  vertical table tab1 at (4,5) = lfs{
    key field logicalFunction
    key field subFunctionL1
    key field subFunctionL2
    key field subFunctionL3
    key field subFunctionL4
    sort-keys logicalFunction, subFunctionL1
  }
}

```

The last step is to define the workbook you want to be displayed. You can also use the `label` key word to provide a name for the worksheet. By default, the worksheet is called `FunctionsTable` if `label` is not specified.

```

workbook {
  worksheet FunctionsTable(logicalFunctionsTable) {label = "LogicalFunctions"}
}

```

Launch the configuration file you created and connect to the IFE sample.

```

import-ecore "http://www.polarsys.org/capella/core/modeller/1.4.0"
import-ecore "http://www.polarsys.org/capella/core/ctx/1.4.0" as sa
import-ecore "http://www.polarsys.org/capella/core/la/1.4.0" as la
import-ecore "http://www.polarsys.org/capella/core/cs/1.4.0" as cs
import-ecore "http://www.polarsys.org/capella/core/information/1.4.0" as info
import-ecore "http://www.polarsys.org/capella/core/core/1.4.0" as core
import-ecore "http://www.polarsys.org/capella/core/oa/1.4.0" as oa
import-ecore "http://www.polarsys.org/capella/core/fa/1.4.0" as fa
import-ecore "http://www.polarsys.org/capella/core/pa/1.4.0" as pa

data-source Root[Project]
data-source architectures =
Root/ownedModelRoots[SystemEngineering]/ownedArchitectures[la::LogicalArchitecture]
data-source logicalFunctions =
architectures/ownedFunctionPkg[la::LogicalFunctionPkg|name="Logical Functions"]

    /ownedLogicalFunctions[la::LogicalFunction|name="Root Logical
Function"]/ownedFunctions[la::LogicalFunction]

synctable-schema LogicalFunctionsSchema {
    record dim [la::LogicalFunction]{
        key column /name as logicalFunction
        column /description as funDescription
    }
    record dim /ownedFunctions[la::LogicalFunction]{
        key column /name as subFunctionL1
    }
    record dim /ownedFunctions[la::LogicalFunction]{
        key column /name as subFunctionL2
    }
    record dim /ownedFunctions[la::LogicalFunction]{
        key column /name as subFunctionL3
    }
    record dim /ownedFunctions[la::LogicalFunction]{
        key column /name as subFunctionL4
    }
}

```

```

synctable logicalFunctionsTable = LogicalFunctionsSchema<LogicalFunctions>

worksheet-template FunctionsTable( lfs : LogicalFunctionsSchema){
    vertical table tab1 at (4,5) = lfs{
        key field logicalFunction
        key field subFunctionL1
        key field subFunctionL2
        key field subFunctionL3
        key field subFunctionL4
        sort-keys logicalFunction, subFunctionL1
    }
}

workbook {
    worksheet FunctionsTable(logicalFunctionsTable) {label = "LogicalFunctions"}
}

```

When you use the above configuration file, Excel will display the functions breakdown as shown.

Entertain with IFE System				
Entertain with IFE System	Command VOD Session			
Entertain with IFE System	Listen to Audio Announcement			
Entertain with IFE System	Select Passenger Service			
Entertain with IFE System	Watch Imposed Movie on Cabin Screen			
Entertain with IFE System	Watch Movie on Private Screen			
IFE System				
IFE System	Manage Audio and Video Diffusion			
IFE System	Manage Audio and Video Diffusion	Process Audio Video Requests		
IFE System	Manage Audio and Video Diffusion	Process Audio Video Requests	Process VOD Movie Controls	
IFE System	Manage Audio and Video Diffusion	Broadcast Stored Audio and Video	Process Imposed Video Controls	
IFE System	Manage Audio and Video Diffusion	Broadcast Stored Audio and Video	Broadcast Audio Video Stream	
IFE System	Manage Audio and Video Diffusion	Broadcast Stored Audio and Video	Prepare Broadcasts	
IFE System	Manage Audio and Video Diffusion	Display Video and Play Audio		
IFE System	Manage Audio and Video Diffusion	Display Video and Play Audio	Play Audio-Video Stream on Seat TV	
IFE System	Manage Audio and Video Diffusion	Display Video and Play Audio	Play Video Stream on Cabin Screen	
IFE System	Manage Audio and Video Diffusion	Display Video and Play Audio	Receive Imposed Video Playing Status	
IFE System	Manage Audio and Video Diffusion	Display Video and Play Audio	Display Imposed Video Playing Status on Cabin T	
IFE System	Manage Audio and Video Diffusion	Display Video and Play Audio	Display Audio Interruption Screen on Seat TV	

In order to get the description for the functions, include a column in each dim and mention it in the worksheet template.

```

synctable-schema LogicalFunctionsSchema {
    record dim [la::LogicalFunction]{
        key column /name as logicalFunction
        column /description as funDescription|
    }
}

```





# 10 Rhapsody Example

## 10.1 Sample MSE File for a Rhapsody Model

For this example, you will create a configuration file to query a Rhapsody Model. The model structure is shown below. You will also create a table to retrieve all the blocks in the Structure package and use the same table to create part properties.

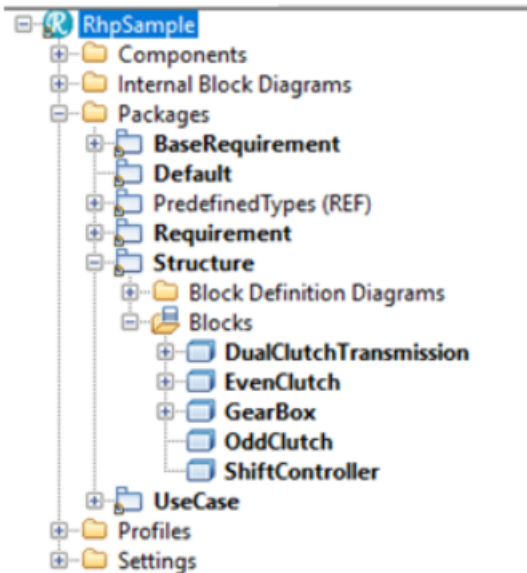

To create the MSE file you can use either:

- The MapleMBSE eclipse editor
- A text editor to create a configuration file.

**Note:** The process for creating the content in the MSE file is the same, regardless of how you created the MSE file.

### Create the MSE File in the Eclipse Editor

If you are using the eclipse editor:

1. Select the File menu.
2. Select New Project(General Project)

3. Click New.
4. Enter a name with extension .MSE
5. Click Ok.

Note: You can use `Ctrl + Space` for auto-suggestions.

### Create the MSE File in a Text Editor

If you are using a text editor:

1. Select the File menu.
2. Select New
3. Select Text Document
4. Enter a name and extension .MSE

### ecore Import

The first step in creating any MSE file is to mention the ecore you are using to query the model. For the Rhapsody model, use the ecore shown below.

```
1 import-ecore "http://w3.ibm.com/Rhapsody/api/"
```

### Data Source

The next step is to create the `data-source` based on the model structure. The data source always starts with the `Root` project.

```
import-ecore "http://w3.ibm.com/Rhapsody/api/"  
data-source Root[REProject]
```

Once you have added the root, you can query the contents inside the project. Use the chained `data-source` to get the packages. Using `nestedElements`, query to get the contents of the `Root` project. This will give us all the packages in the project.

```
import-ecore "http://w3.ibm.com/Rhapsody/api/"

data-source Root[REProject]
data-source pkg = Root/nestedElements[REPackage]
```

For this example, only the `Structure` package is of interest. You will need to add a filter based on the package name to the qualified `[REPackage]`.

```
import-ecore "http://w3.ibm.com/Rhapsody/api/"

data-source Root[REProject]
data-source pkg = Root/nestedElements[REPackage|name="Structure"]]
```

This will give you access to the `Structure` package. Now you can either create a new `data-source` to get the blocks from the `Structure` package or continue with `pkg data-source` to get the blocks.

```
import-ecore "http://w3.ibm.com/Rhapsody/api/"

data-source Root[REProject]
data-source pkg = Root/nestedElements[REPackage|name="Structure"]
data-source blk = pkg/nestedElements[REClass]
```

Add a new data source called `blk` to get all of the blocks under the `Structure` package. Notice from the `blk` data source, only the `Class` was queried and not the blocks, specifically. To get and add blocks to the model include a filter for a `Block` stereotype.

```
import-ecore "http://w3.ibm.com/Rhapsody/api/"

data-source Root[REProject]
data-source pkg = Root/nestedElements[REPackage|name="Structure"]
data-source blk = pkg/nestedElements[REClass|userDefinedMetaClass="Block"]]
```

## synctable-schema

Add a `synctable-schema` called `BlocksTableSchema`. Next, add the first `dim` based on the `data-source`. We will be using the same `Classifier` in the table schema that was used for the `data-source`. Using `name` as the unique identifier in the block `dim`.

```

synctable-schema BlocksTableSchema {
    record dim [REClass|userDefinedMetaClass="Block"]{
        key column /name as blockName
    }
}

```

This will give you all the blocks from the Structure package. Add a dim to get the part properties of the block. These properties are stored as REInstance with stereotype Object in the ecore definition. Hence, you have to use the same in the queries.

```

import-ecore "http://w3.ibm.com/Rhapsody/api/"

data-source Root[REProject]
data-source pkg = Root/nestedElements[REPackage|name="Structure"]
data-source blk = pkg/nestedElements[REClass|userDefinedMetaClass="Block"]

synctable-schema BlocksTableSchema {
    record dim [REClass|userDefinedMetaClass="Block"]{
        key column /name as blockName
    }
    record dim /nestedElements[REInstance|userDefinedMetaClass="Object"]{
}
}

```

At this point, you must use the reference because the part refers another block. From SysML, the part properties are typed by another block and this block is not directly owned by the top-level block. Again, you must rely on the ecore to create the reference with otherClass and then use the reference.

```

synctable-schema BlocksTableSchema {
    record dim [REClass|userDefinedMetaClass="Block"]{
        key column /name as blockName
    }
    record dim /nestedElements[REInstance|userDefinedMetaClass="Object"]
        .otherClass[REClass|userDefinedMetaClass="Block"] @ refclass {
}
}

```

The above query is same as using reference-query the screenshot below shows possible options that can be used.

```

record dim /nestedElements[REInstance|userDefinedMetaClass="Object"]
    .otherClass[REClass|userDefinedMetaClass="Block"] @ refclass {
    }
or
record dim /nestedElements[REInstance|userDefinedMetaClass="Object"]{
    key reference-query .otherClass[REClass|userDefinedMetaClass="Block"] @refclass
}
}

```

Now add reference decomposition to list all the blocks that can be added as part. Before moving further, you need to add a new synctable schema which can be used to for the reference.

```

} synctable-schema BlocksTableReference {
}   record dim [REClass|userDefinedMetaClass="Block"]{
    key column /name as refblockName
    }
}

```

Use this new schema for reference. Remember to add the table being referenced in the synctable-schema definition. As the refblockName is added as a key column in BlockTableReference use foreign-key column..

```

synctable-schema BlocksTableSchema(brs : BlocksTableReference) {
    record dim [REClass|userDefinedMetaClass="Block"]{
        key column /name as blockName
    }
    record dim /nestedElements[REInstance|userDefinedMetaClass="Object"]
        .otherClass[REClass|userDefinedMetaClass="Block"] @ refclass {
            reference-decomposition refclass = brs {
                foreign-key column refblockName as partBlock
            }
        }
}
}

```

You have defined the hierarchy for one level down. Repeat the same block as needed to create multiple levels. At each level, change the name of the block and the reference parameter(refclass). For the simplicity of the example, just add one additional level.

```

synctable-schema BlocksTableSchema(brs : BlocksTableReference) {
  record dim [REClass|userDefinedMetaClass="Block"]{
    key column /name as blockName
  }
  record dim /nestedElements[REInstance|userDefinedMetaClass="Object"]
    .otherClass[REClass|userDefinedMetaClass="Block"] @ refclass {
    reference-decomposition refclass = brs {
      foreign-key column refblockName as partBlock
    }
  }
  record dim /nestedElements[REInstance|userDefinedMetaClass="Object"]
    .otherClass[REClass|userDefinedMetaClass="Block"] @ refclass {
    reference-decomposition refclass = brs {
      foreign-key column refblockName as partBlock1
    }
  }
}

```

The last task left to do is for the schema is to link it with the appropriate data-source and the reference table. In our case, all of the blocks are from the same data-source called `blk`.

```

synctable referenceTable = BlocksTableReference<blk>
synctable blocksTableSchema = BlocksTableSchema<blk>(referenceTable)

```

## Worksheet Template

In this step, define the order of the columns, the table placement and the kind of table you want to display. Create a template to display a vertical table that starts from row three and column four. You should also specify the schema for which the template is defined.

```

worksheet-template BlocksTable(blocks: BlocksTableSchema) {
  vertical table tab1 at (3, 4) = blocks {
    unmapped-field
    key field blockName : String
    key field partBlock : String
    key field partBlock1 : String
    sort-keys blockName, partBlock, partBlock1
  }
}

```

The last step is to define the workbook and list the worksheet you want to display.

```

import-ecore "http://w3.ibm.com/Rhapsody/api/"

data-source Root[REProject]
data-source pkg = Root/nestedElements[REPackage|name="Structure"]
data-source blk = pkg/nestedElements[REClass|userDefinedMetaClass="Block"]

synctable-schema BlocksTableSchema( brs : BlocksTableReference ) {
    record dim [REClass|userDefinedMetaClass="Block"]{
        key column /name as blockName
    }
    record dim /nestedElements[REInstance|userDefinedMetaClass="Object"]

    .otherClass[REClass|userDefinedMetaClass="Block"] @ refclass {
        reference-decomposition refclass = brs {
            foreign-key column refblockName as partBlock
        }
    }
    record dim /nestedElements[REInstance|userDefinedMetaClass="Object"]

    .otherClass[REClass|userDefinedMetaClass="Block"] @ refclass1 {
        reference-decomposition refclass1 = brs {
            foreign-key column refblockName as partBlock1
        }
    }
}

synctable-schema BlocksTableReference {
    record dim [REClass|userDefinedMetaClass="Block"]{
        key column /name as refblockName
    }
}

```

```

synctable referenceTable = BlocksTableReference<blk>
synctable blocksTableSchema = BlocksTableSchema<blk>(referenceTable)

worksheet-template BlocksTable(blocks: BlocksTableSchema) {
  vertical table tab1 at (3, 4) = blocks {
    unmapped-field
    key field blockName : String
    key field partBlock : String
    key field partBlock1 : String
    sort-keys blockName, partBlock, partBlock1
  }
}

workbook{
  worksheet BlocksTable(blocksTableSchema)
}

```

Run the configuration and connect to a sample model. Expected table for the model shown.

DualClutchTransmission		
DualClutchTransmission	EvenClutch	
DualClutchTransmission	GearBox	
DualClutchTransmission	OddClutch	
DualClutchTransmission	ShiftController	
EvenClutch		
GearBox		
OddClutch		
ShiftController		

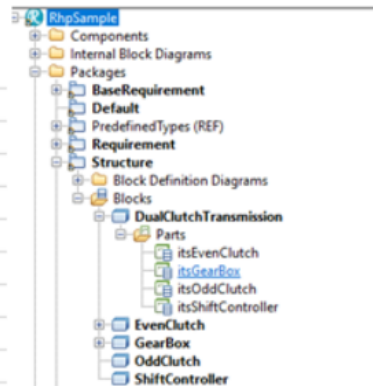



# 11 Teamwork Cloud Example

## 11.1 Sample MSE File for a Teamwork Cloud Model

Based on the QPE context presented in the previous chapters, you will create an example MSE file to view and edit the blocks, ports and port types in a Teamwork Cloud SysML model.

The model structure is as shown below.

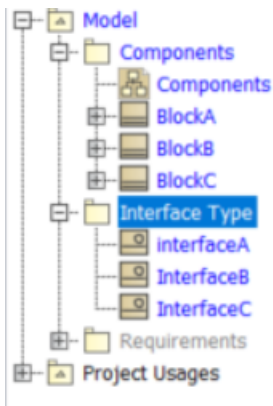

The blocks are in a package called **Components** and the interface type in **Interface Type** package.

As a prerequisite, you should be familiar with the MapleMBSE virtual features. You can find detailed information on MapleMBSE virtual features in the [virtual features guide](#).

To create the MSE file you can use either:

- The MapleMBSE eclipse editor
- A text editor to create a configuration file.

**Note:** The process for creating the content in the MSE file is the same, regardless of how you created the MSE file.

## Create the MSE File in the Eclipse Editor

If you are using the eclipse editor:

1. Select the File menu.
2. Select New Project(General Project)
3. Click New.
4. Enter a name with extension .MSE
5. Click Ok.

Note: You can use `Ctrl + Space` for auto-suggestions.

## Create the MSE File in a Text Editor

If you are using a text editor:

1. Select the File menu.
2. Select New
3. Select Text Document
4. Enter a name and extension .MSE

## ecore Import

The first step in any MSE file is to mention the ecore you are using to query the model. For the TWC model, use the `http://www.nomagic.com/magicdraw/UML/2.5.1` ecore. Since you will be using the virtual features, you also need to import the MapleMBSE ecore as shown below.

```
import-ecore "http://www.nomagic.com/magicdraw/UML/2.5.1"  
import-ecore "http://maplembse.maplesoft.com/common/1.0" as mse
```

## Data Source

Next, use the project structure in Teamwork Cloud to define a data source to get the set of elements you want to view/edit in MapleMBSE. The default top level data structure is the `Root` model

```
import-ecore "http://www.nomagic.com/magicdraw/UML/2.5.1"  
import-ecore "http://maplembse.maplesoft.com/common/1.0" as mse  
  
data-source Root[Model]
```

This will give us the top `Model` package.

## List of Blocks from Data Source

To get the list of blocks in the component package, use the chained data source (check section for more details, [hyperlink](#)). Create a data source called `components` and navigate to the subpackage.

```
import-ecore "http://www.nomagic.com/magicdraw/UML/2.5.1"
import-ecore "http://maplembse.maplesoft.com/common/1.0" as mse

data-source Root[Model]
data-source components = Root/packagedElement[Package]
```

From `Root`, use `packagedElement` to get model elements of type `Package`. This will give all the packages under the `Model`. Next, add an attribute filter ([hyperlink to attribute filter](#)) to get only the contents of the `Components` package. Using `name` as the attribute filter in the qualifier.

```
import-ecore "http://www.nomagic.com/magicdraw/UML/2.5.1"
import-ecore "http://maplembse.maplesoft.com/common/1.0" as mse

data-source Root[Model]
data-source components = Root/packagedElement[Package|name="Components"]
```

You can create another chained data source to get all the blocks from the `components` data-source or you can continue to navigate to the blocks from the `components`.

```
import-ecore "http://www.nomagic.com/magicdraw/UML/2.5.1"
import-ecore "http://maplembse.maplesoft.com/common/1.0" as mse

data-source Root[Model]
data-source components = Root/packagedElement[Package|name="Components"]/packagedElement[Class]
or:
data-source blocks = components/packagedElement[Class]
```

A block is defined as a `Class` with stereotype `Block` in the TWC `ecore`. Follow the same by navigating to the `Class` and adding a stereotype.

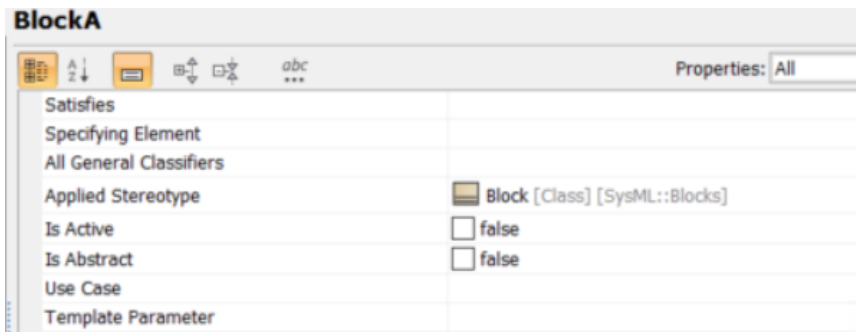

To add a stereotype to the class, use a virtual feature called `metaClassName` (see section 2.1 of the [virtual features guide](#)). The value of stereotype is the **Qualified Name** of the respective stereotypes. From the Blocks specification menu, right-click on the **Applied Stereotype** field and select **Specification** (In Magic Draw or Cameo Systems Modeler).

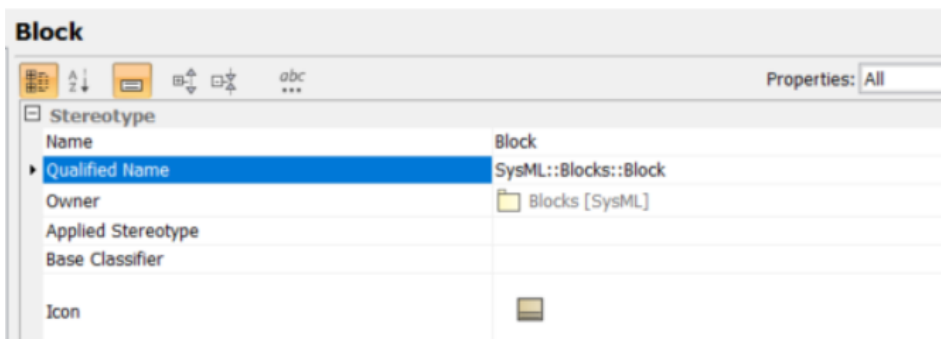

```
import-ecore "http://www.nomagic.com/magicdraw/UML/2.5.1"
import-ecore "http://maplembse.maplesoft.com/common/1.0" as mse

data-source Root[Model]
data-source components = Root/packagedElement[Package[name="Components"]
                        /packagedElement[Class|mse::metaClassName="SysML::Blocks::Block"]]
```

You have successfully navigated to the Blocks.

## synctable-schema

Next, create a schema to define how the model elements are mapped to a table. Create a `synctable-schema` called `ComponentsSchema`.

```

import-ecore "http://www.nomagic.com/magicdraw/UML/2.5.1"
import-ecore "http://maplembse.maplesoft.com/common/1.0" as mse

data-source Root[Model]
data-source components = Root/packagedElement[Package|name="Components"]
                        /packagedElement[Class|mse::metaClassName="SysML::Blocks::Block"]

|synctable-schema ComponentsSchema{
}

```

In the schema, add a `dim` (hyperlink for dims) for Blocks to get the blocks name. In a schema based on the `data-source` you want to assign, you start with the same query in most cases. Every `dim` should have at least one `key column` that is unique. Use `name` as `key column`.

Using `record` before a `dim` will uniquely assign a row to that `dim`. (You can include comments in the MSE file using `//`)

```

import-ecore "http://www.nomagic.com/magicdraw/UML/2.5.1"
import-ecore "http://maplembse.maplesoft.com/common/1.0" as mse

data-source Root[Model]
data-source components = Root/packagedElement[Package|name="Components"]\
                        /packagedElement[Class|mse::metaClassName="SysML::Blocks::Block"]
//This schema gets Block name, Port Name and type
|synctable-schema ComponentsSchema{
  record dim[Class|mse::metaClassName="SysML::Blocks::Block"]{
    key column /name as blockName
  }
}

```

Every subsequent `dim` will query details of the previous `dim`. For example, in this `dim` you can get properties and instances of the block defined in the previous `dim`.

The `ecore` defines properties as owned Attributes. You can also find possible queries as auto-suggestions in Eclipse or from the specification window of that model element.

A block can have part properties, value properties, ports etc. All these are differentiated by stereotypes added. In this case, you would want to get the proxy ports for the block. Follow the same steps as the previous `dim` to identify the stereotype for a proxy port.

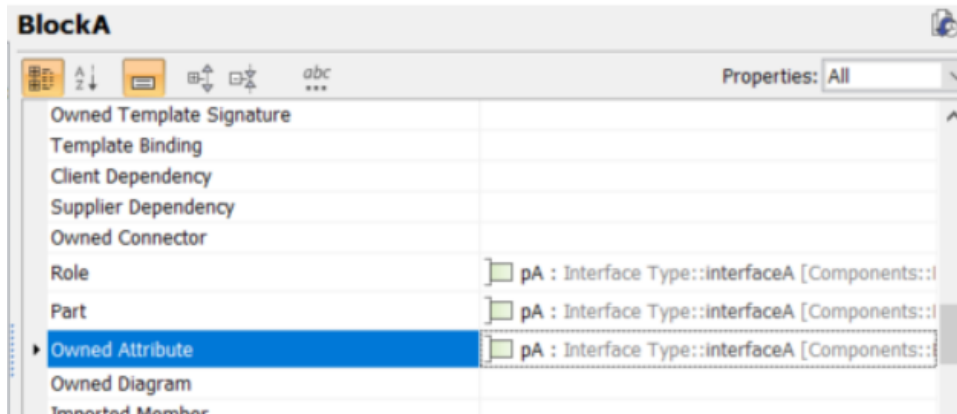

```

import-ecore "http://www.nomagic.com/magicdraw/UML/2.5.1"
import-ecore "http://maplembse.maplesoft.com/common/1.0" as mse

data-source Root[Model]
data-source components = Root/packagedElement[Package|name="Components"]
                        /packagedElement[Class|mse::metaclassName="SysML::Blocks::Block"]
//This schema gets Block name, Port Name and type

synctable-schema ComponentsSchema{
  record dim[Class|mse::metaclassName="SysML::Blocks::Block"]{
    key column /name as blockName
  }
  dim /ownedAttribute[Property|mse::metaclassName="SysML::Ports&Flows::ProxyPort"]{
    key column /name as portName
  }
}

```

Using `record` key word in the last `dim` is optional by default because the last `dim` is always a record column. The properties of the Classifiers are called attributes. For example name is an attribute of `Block` and `Port`.

You have to use the `reference-query` and `reference-decomposition` (see section 6.6 of the [configuration guide](#)) to be able to get the interface types defined. The type of the port is a reference value because the type is not owned by the port but it is just a reference to a different model element.

You need to create another table to reference the possible values for interface type. Before you can go any further with this `synctable-schema` you have to create another table for interfaces.

Define another `synctable` to query the interfaces. Start with defining a `data-source` and then the `synctable-schema` to get the details.

```

import-ecore "http://www.nomagic.com/magicdraw/UML/2.5.1"
import-ecore "http://maplembse.maplesoft.com/common/1.0" as mse

data-source Root[Model]
data-source components = Root/packagedElement[Package|name="Components"]
                        /packagedElement[Class|mse::metaclassName="SysML::Blocks::Block"]
//This schema gets Block name, Port Name and type

synctable-schema ComponentsSchema{
  record dim[Class|mse::metaclassName="SysML::Blocks::Block"]{
    key column /name as blockName
  }
  dim /ownedAttribute[Property|mse::metaclassName="SysML::Ports&Flows::ProxyPort"]{
    key column /name as portName
  }
}

data-source interfaceType = Root/packagedElement[Package|name="Interface Type"]
                        /packagedElement[Class|mse::metaclassName="SysML::Ports&Flows::InterfaceBlock"]

```

Next, a `synctable-schema` to get names of the interface blocks.

```

import-ecore "http://www.nomagic.com/magicdraw/UML/2.5.1"
import-ecore "http://maplembse.maplesoft.com/common/1.0" as mse

data-source Root[Model]
data-source components = Root/packagedElement[Package|name="Components"]
                        /packagedElement[Class|mse::metaclassName="SysML::Blocks::Block"]
//This schema gets Block name, Port Name and type

synctable-schema ComponentsSchema{
  record dim[Class|mse::metaclassName="SysML::Blocks::Block"]{
    key column /name as blockName
  }
  dim /ownedAttribute[Property|mse::metaclassName="SysML::Ports&Flows::ProxyPort"]{
    key column /name as portName
  }
}

//data source to get interface blocks
data-source interfaceType = Root/packagedElement[Package|name="Interface Type"]
                        /packagedElement[Class|mse::metaclassName="SysML::Ports&Flows::InterfaceBlock"]
//schema to be used as reference
synctable-schema InterfaceBlocksSchema{
  record dim[Class|mse::metaclassName="SysML::Ports&Flows::InterfaceBlock"]{
    key column /name as interfaceName
  }
}

```

The `InterfaceBlocks` schema is ready to be referenced in the `ComponentsSchema`.

In the `components` schema you create a reference for the type of the port. Use `ibs` as a parameter to reference the table in `ComponentsSchema`.

```

import-ecore "http://www.nomagic.com/magicdraw/UML/2.5.1"
import-ecore "http://maplembe.maplesoft.com/common/1.0" as mse

data-source Root[Model]
data-source components = Root/packagedElement[Package|name="Components"]
                        /packagedElement[Class|mse::metaclassName="SysML::Blocks::Block"]

//This schema gets Block name, Port Name and type

synctable-schema ComponentsSchema(ibs: InterfaceBlocksSchema){ //table to be referenced
  record dim[Class|mse::metaclassName="SysML::Blocks::Block"]{
    key column /name as blockName
  }
  dim /ownedAttribute[Property|mse::metaclassName="SysML::Ports&Flows::ProxyPort"]{
    key column /name as portName
  }
}

//data source to get interface blocks
data-source interfaceType = Root/packagedElement[Package|name="Interface Type"]
                        /packagedElement[Class|mse::metaclassName="SysML::Ports&Flows::InterfaceBlock"]

//schema to be used as reference
synctable-schema InterfaceBlocksSchema{
  record dim[Class|mse::metaclassName="SysML::Ports&Flows::InterfaceBlock"]{
    key column /name as interfaceName
  }
}

```

InterfaceBlocks is a class so in the qualifier for the reference, the reference type is mentioned as Class.

```

import-ecore "http://www.nomagic.com/magicdraw/UML/2.5.1"
import-ecore "http://maplembe.maplesoft.com/common/1.0" as mse

data-source Root[Model]
data-source components = Root/packagedElement[Package|name="Components"]
                        /packagedElement[Class|mse::metaclassName="SysML::Blocks::Block"]

//This schema gets Block name, Port Name and type

synctable-schema ComponentsSchema(ibs: InterfaceBlocksSchema){ //table to be referenced
  record dim[Class|mse::metaclassName="SysML::Blocks::Block"]{
    key column /name as blockName
  }
  dim /ownedAttribute[Property|mse::metaclassName="SysML::Ports&Flows::ProxyPort"]{
    key column /name as portName

    reference-query .type[Class] @interfaceRef
  }
}

//data source to get interface blocks
data-source interfaceType = Root/packagedElement[Package|name="Interface Type"]
                        /packagedElement[Class|mse::metaclassName="SysML::Ports&Flows::InterfaceBlock"]

//schema to be used as reference
synctable-schema InterfaceBlocksSchema{
  record dim[Class|mse::metaclassName="SysML::Ports&Flows::InterfaceBlock"]{
    key column /name as interfaceName
  }
}

```

With the Reference query part complete, use reference decomposition to get information from the InterfaceBlocksSchema. Reference decomposition.



```

import-ecore "http://www.nomagic.com/magicdraw/UML/2.5.1"
import-ecore "http://maplembse.maplesoft.com/common/1.0" as mse

data-source Root[Model]
#data-source components = Root/packagedElement[Package|name="Components"]
                        /packagedElement[Class|mse::metaclassName="SysML::Blocks::Block"]

//This schema gets Block name, Port Name and type

#synctable-schema ComponentsSchema(ibs: InterfaceBlocksSchema){ //table to be referenced
# record dim[Class|mse::metaclassName="SysML::Blocks::Block"]{
    key column /name as blockName
}
# dim /ownedAttribute[Property|mse::metaclassName="SysML::Ports&Flows::ProxyPort"]{
    key column /name as portName

    reference-query .type[Class] @interfaceRef
    reference-decomposition interfaceRef = ibs{
        foreign-key column interfaceName as portType
    }
}
}

//data source to get interface blocks
#data-source interfaceType = Root/packagedElement[Package|name="Interface Type"]
                        /packagedElement[Class|mse::metaclassName="SysML::Ports&Flows::InterfaceBlock"]

//schema to be used as reference
#synctable-schema InterfaceBlocksSchema{
# record dim[Class|mse::metaclassName="SysML::Ports&Flows::InterfaceBlock"]{
    key column /name as interfaceName
}
}

```

The synctable definitions are complete. You now have to link the data-source and synctable-schema.

```

import-ecore "http://www.nomagic.com/magicdraw/UML/2.5.1"
import-ecore "http://maplembse.maplesoft.com/common/1.0" as mse

data-source Root[Model]
data-source components = Root/packagedElement[Package|name="Components"]
                        /packagedElement[Class|mse::metaClassName="SysML::Blocks::Block"]

//This schema gets Block name, Port Name and type

synctable-schema ComponentsSchema(ibs: InterfaceBlocksSchema){ //table to be referenced
  record dim[Class|mse::metaClassName="SysML::Blocks::Block"]{
    key column /name as blockName
  }
  dim /ownedAttribute[Property|mse::metaClassName="SysML::Ports&Flows::ProxyPort"]{
    key column /name as portName

    reference-query .type[Class] @interfaceRef
    reference-decomposition interfaceRef = ibs{
      foreign-key column interfaceName as portType
    }
  }
}

//data source to get interface blocks
data-source interfaceType = Root/packagedElement[Package|name="Interface Type"]
                        /packagedElement[Class|mse::metaClassName="SysML::Ports&Flows::InterfaceBlock"]

//schema to be used as reference
synctable-schema InterfaceBlocksSchema{
  record dim[Class|mse::metaClassName="SysML::Ports&Flows::InterfaceBlock"]{
    key column /name as interfaceName
  }
}

//linking the synctable-schema with a data-source
synctable interfaceBlockTable = InterfaceBlocksSchema<interfaceType>

```

In the case of the components table, make sure that the synctable accounts for the reference that you have included, as shown below.

```

import-ecore "http://www.nomagic.com/magicdraw/UML/2.5.1"
import-ecore "http://maplemse.maplesoft.com/common/1.0" as mse

data-source Root[Model]
data-source components = Root/packagedElement[Package{name="Components"}
                        /packagedElement[Class{mse::metaClassName="SysML::Blocks::Block"}]

//This schema gets Block name, Port Name and type
synctable-schema ComponentsSchema(ibs: InterfaceBlocksSchema){ //table to be referenced
  record dim[Class{mse::metaClassName="SysML::Blocks::Block"}]{
    key column /name as blockName
  }
  dim /ownedAttribute[Property{mse::metaClassName="SysML::Ports&Flows::ProxyPort"}]{
    key column /name as portName

    reference-query .type[Class] @interfaceRef
    reference-decomposition interfaceRef = ibs{
      foreign-key column interfaceName as portType
    }
  }
}

//data source to get interface blocks
data-source interfaceType = Root/packagedElement[Package{name="Interface Type"}
                        /packagedElement[Class{mse::metaClassName="SysML::Ports&Flows::InterfaceBlock"}]

//schema to be used as reference
synctable-schema InterfaceBlocksSchema{
  record dim[Class{mse::metaClassName="SysML::Ports&Flows::InterfaceBlock"}]{
    key column /name as interfaceName
  }
}

//linking the synctable-schema with a data-source
synctable interfaceBlockTable = InterfaceBlocksSchema<interfaceType>
synctable componentsTable = ComponentsSchema<components>(interfaceBlockTable) // use the synctable name and not the schema

```

In the above steps you transformed the model information into a table. In the following section, you will control the information displayed in Excel.

## Worksheet Template

In this step you will define the order of the columns, the table placement and the kind of table you want to display.

Create a template to display a vertical table that starts from row three and column four. You should also specify the schema for which the template is defined.

```

worksheet-template ComponentsTable( ct : ComponentsSchema){
  vertical table tab1 at (3,4) = ct{

}
}

```

For each column you defined in the `ComponentsSchema`, define a `field`.

```

worksheet-template ComponentsTable( ct : ComponentsSchema){
  vertical table tab1 at (3,4) = ct{
    key field blockName
    key field portName
    field portType
  }
}

```

If you want the model elements to be sorted use `sort-keys` and then the field to be sorted.

```

worksheet-template ComponentsTable( ct : ComponentsSchema){
  vertical table tab1 at (3,4) = ct{
    key field blockName
    key field portName
    field portType
    sort-keys blockName, portName
  }
}

```

Finally, define the workbook and list the worksheet you want to be displayed.

```

import-ecore "http://www.nomagic.com/magicdraw/UML/2.5.1"
import-ecore "http://maplembse.maplesoft.com/common/1.0" as mse

data-source Root[Model]
data-source components = Root/packagedElement[Package|name="Components"]
/packagedElement[Class|mse::metaclassName="SysML::Blocks::Block"]
//This schema gets Block name, Port Name and type

synctable-schema ComponentsSchema(ibs: InterfaceBlocksSchema){ //table to be
referenced
  record dim[Class|mse::metaclassName="SysML::Blocks::Block"]{
    key column /name as blockName
  }
  dim
/ownedAttribute[Property|mse::metaclassName="SysML::Ports&Flows::ProxyPort"]{
  key column /name as portName

  reference-query .type[Class] @interfaceRef
  reference-decomposition interfaceRef = ibs{
    foreign-key column interfaceName as portType
  }
}
}

```

```

//data source to get interface blocks
data-source interfaceType = Root/packagedElement[Package|name="Interface Type"]

    /packagedElement[Class|mse::metaclassName="SysML::Ports&Flows::InterfaceBlock"
]

//schema to be used as reference
synctable-schema InterfaceBlocksSchema{
    record dim[Class|mse::metaclassName="SysML::Ports&Flows::InterfaceBlock"]{
        key column /name as interfaceName
    }
}

//linking the synctable-schema with a data-source
synctable interfaceBlockTable = InterfaceBlocksSchema<interfaceType>
synctable componentsTable = ComponentsSchema<components>(interfaceBlockTable) // use
the synctable name and not the schema

worksheet-template ComponentsTable( ct : ComponentsSchema){
    vertical table tab1 at (3,4) = ct{
        key field blockName
        key field portName
        field portType
        sort-keys blockName, portName
    }
}

workbook{
    worksheet ComponentsTable(componentsTable)
}

```

Double click on the file and connect to the model with similar structure from the image below. Expected table in Excel.

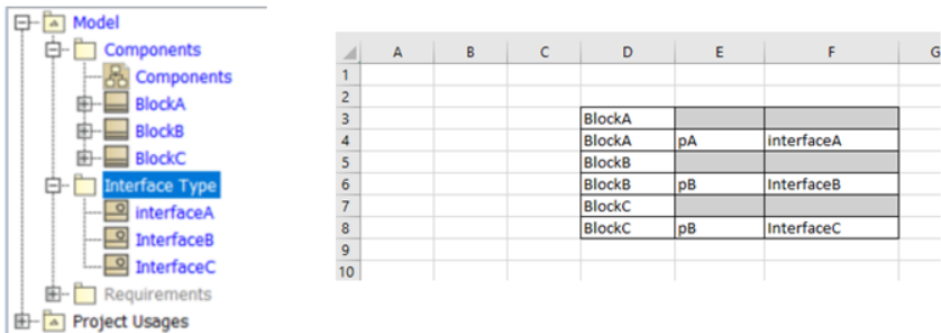



# Index

## A

- Attribute Filter, 27
- attribute filters
  - creating a new element, 27
  - gathering elements from the model, 27

## C

- Capella example, 65
  - creating MSE file, 71
    - adding the data source, 66
    - creating the synctable schema, 67
    - creating the worksheet template, 68
  - importing ecore, 66
  - using Eclipse editor, 65
  - using text editor, 65
- configuration file
  - formal definition, 25
  - overview, 25
- configuration file fundamentals
  - EcoreImport, 26
- configuration language fundamentals, 25
  - notation, 25
- Creating a Configuration File, 11

## D

- data source, 37
  - all primary data source, 38
  - chained data source, 38
  - ChainedDataSource, 37
  - primary data source, 38
  - Root, 37
- Data Source
  - syntax, 37

## E

- Elements of a Configuration File, 1

## I

- Installing the MSE Configuration Editor, 7
- Introduction, 1
- Introductory Example, 23
  - adding the data source, 19
  - creating a template file, 23
  - defining a dimension, 19
  - Defining a SyncTable Schema, 18
  - Importing the Ecore, 18

## L

- Launching MapleMBSE from the Command Line, 17

## M

- MapleMBSE command line syntax, 17
- MapleMBSE Configuration Plugin
  - MSE File
    - Creating, MapleMBSE Plugin, 3
- MapleMBSE Mapping
  - DataSource, 1
  - Overview, 1
  - SyncTable, 1
  - SyncTable Schema, 1
  - SyncView Layout, 1
- MSE Configuration Editor
  - Installation, 7
- MSE configuration editor
  - download
    - URL, 4
- MSE File
  - Creating, 11
- MSE file
  - formal definition, 25
  - overview, 25

## P

- Predicate Filters, 29
- predicate filters
  - steps to creating, 29
    - creating the filter logic, 29

- creating the filter logic,n-ary predicates, 29
- creating the filter logic,n-ary predicates, AND, 29
- creating the filter logic,n-ary predicates, OR, 29
- creating the filter logic,n-ary predicates, OR1, 29
- creating the filter logic,n-ary predicates, Propositions, 30
- creating the filter logic,Propositions, Attribute Proposition, 30
- creating the filter logic,Propositions, Counting Proposition, 31
- creating the filter logic,Propositions, Inequality Proposition, 30
- creating the filter logic,Propositions, Reference Proposition, 30
- creating the filter logic,Propositions, Subset Proposition, 30
- creating the filter logic,unary predicates, 29
- creating the filter logic,unary predicates,NOT, 29
- defining the predicate, 29
- using the predicate filter, 31

## Q

- Qualifiers, 27
  - Attribute Filters, 27
  - Predicate Filters, 29
  - Reference Filters, 28
- query path expression
  - attribute
    - definition, 33
  - classifier
    - definition, 33
  - definition, 35
  - example, 33
  - formal syntax, 33
  - reference
    - definition, 33

## R

- Reference Filters, 28
- restarting MapleMBSE from the command line with shortcut key, 18
- Rhapsody example, 73
  - add a data source, 74
  - add a synctable schema, 75
  - creating MSE file, 79
    - Eclipse editor, 73
    - text editor, 74
  - creating the worksheet template, 78
  - ecore import, 74

## S

- SyncTable
  - introduction, 55
  - syntax, 55
- SyncTable Schema, 39
  - alternative and group dimensions, 45
  - default value generation, 53
    - data insertion order, 51
    - limitations, 51
  - defining key columns, 49
  - examples, 40
  - mapping attribute values of model elements to columns, 40
  - mapping dimensions to records, 41
  - overview, 39
  - ReferenceDecomposition, 47
    - example, 46
    - mapping reference values, 46
  - ReferenceQuery, 47
    - mapping reference values, 46
  - References by dimensions or ReferenceQuery, 48
  - syntax, 39
- SyncViews, 57
  - matrix view layout, 60
  - read-only worksheets, 63
  - setting up a workbook and worksheets, 57
  - table view layout, 58



- syntax, 58, 60
- worksheet template and view layout, 61
- worksheet template syntax, 58

## T

- Teamwork Cloud example, 81
  - creating MSE file, 93
    - adding the data source, 82
    - adding the data source, list of blocks, 83
  - creating the synctable schema, 84
  - creating the worksheet template, 91
  - importing ecore, 82
  - using Eclipse editor, 82
  - using text editor, 82

